

# Panasonic

## OVERVIEW

PROGRAMMABLE LOGIC CONTROLLERS



## Advantages of PLC control



### Powerful hardware solutions

Panasonic PLCs offer an outstanding price-performance ratio which incorporates numerous functions into a very compact body. Even in the smallest size they provide a powerful instruction set which allows the system to handle demanding tasks such as analog control, networking and positioning control.

### Innovative programming software

Our PLC programming software Control FPCWIN Pro was one of the first on the market conforming to the international standard IEC 61131-3. Numerous libraries that incorporate a lot of our know-how ensure the reusability of ready-made functions and function blocks and save time for programming and debugging.

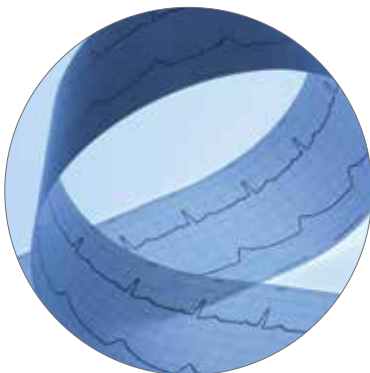

### Long-life quality

As with all Panasonic products, the PLCs undergo extremely rigorous testing during development that far exceeds the demands that will actually be placed on them. This is a guarantee for the long life of the product in the application.

### Benefit from good service

In addition to a comprehensive PLC range, Panasonic also offers the high-quality care demanded from a service-oriented company certified according to ISO 9001.

Highly trained application engineers can provide custom designed systems. The sales staff regularly participates in hardware and software training courses.



# Content

Advantages & overview . . . . .	2–3	FP Web-Server . . . . .	34–35
FP-e series . . . . .	4–5	Control FP Win Pro . . . . .	36
FP0R series . . . . .	6–11	FP Web Designer . . . . .	38
FPΣ (Sigma) series . . . . .	12–19	FMU/FSU . . . . .	39–40
FP-X series . . . . .	20–25	FP Modem . . . . .	40–41
FP-X0 series . . . . .	26–27	Other programming tools . . . . .	42–44
FP7 series . . . . .	28–33	KS1 . . . . .	45
Power supply units . . . . .	34	Part number list . . . . .	46–54

# Overview

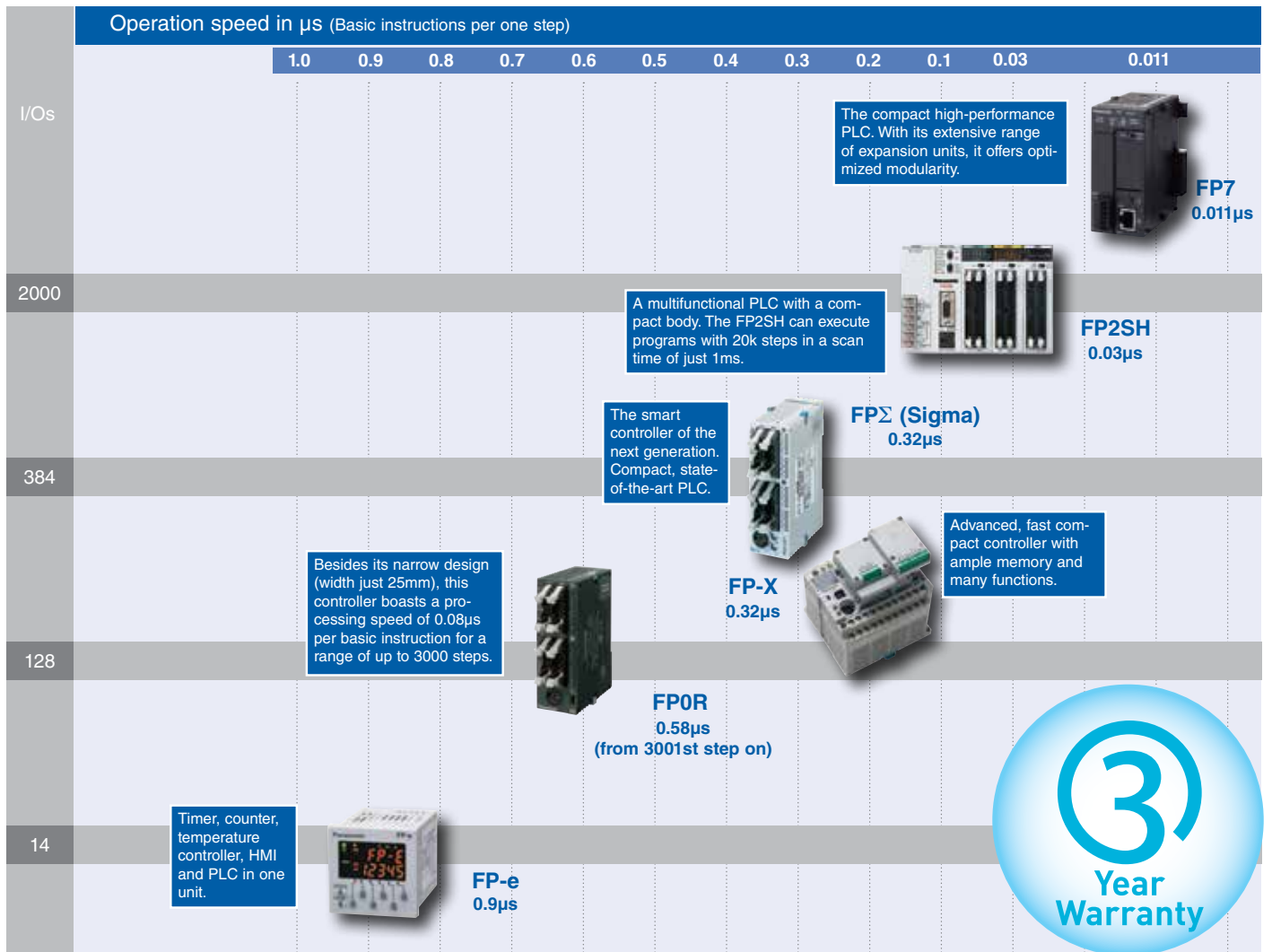

## All in one: Timer, counter, hour meter, temperature controller & PLC

### Features

- 5-character, 2-line, 3-color display
- Front operation switch
- Easy programming using wizard
- Smooth debug
- Panel mounted type



### Display modes and functions

#### N mode

(Normal mode)

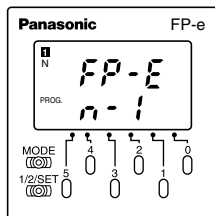

Displays any characters and numerical values, and numerical data can be changed.

#### S mode

(Switch mode)

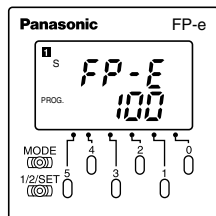

Can also display characters and numerical values. Operation switches can be used for input.

#### R mode

(Register mode)

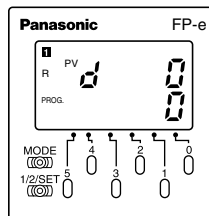

Operation memory in the controller can be monitored and its data can be changed.

#### I mode

(I/O monitor mode)

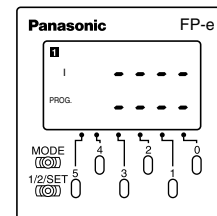

I/O status (X, Y) in the controller can be displayed.

### Specifications

Model		AFPE224300 Standard type (RS232C)	AFPE224302 Standard type (RS485)	AFPE224305 RTC type (RS232C)	AFPE214325 Thermocouple input type (RS232C)	AFPE214322 Thermocouple input type (RS485)
Number of I/O points	Control unit	14 points [Input: 8, Output: 6 (Tr. NPN: 5/Ry: 1)]			12 points [Input: 6, Output: 6 (Tr. NPN: 5/Ry: 1)]	
	Front switch input	8 points				
Program memory		Built-in EEPROM				
Program capacity		2720 steps				
Processing speed		0.9μs/step (for basic instruction)				
Clock/calendar function		-			Available (year, month, day, hour, minute, second and day of week). However, this can only be used when a battery has been installed.	
Battery life		-			220 days or more (actual usage value: approx. 870 days (25°C) (Periodic replacement interval: 1 year) (Value applies when no power is supplied at all.)	
Pulse catch input/interrupt input		6 points in total (X0 and X1: 50μs, X2 to X5: 100μs)				
COM port		RS232C	RS485	RS232C	RS232C	RS485
Periodical interrupt		0.5ms to 30s				
Special functions	High-speed counter The combination of single-phase x 2ch and two-phase x 1ch is also possible for the high-speed counter	Counter mode: Incremental/decremental (single-phase) - input points: 4ch (max.)				
	Pulse output	Output points			2 independent points (No interpolation function)	
	Pulse output	Output frequency			40Hz to 5kHz (1-point), 40Hz to 2.5kHz (2-points)	
	PWM output	Output points			2 points	
PWM output	Output frequency			Frequency: 0.15Hz to 1kHz    Duty: 0.1% to 99.9%		

# Optimized for a wide range of applications

## RS485 and RS232C interfaces

Up to 99 MEWTOCOL-COM stations possible with RS485 (RS485 type)

Up to 32 MEWTOCOL-COM stations are possible using a C-NET adapter and up to 99 are possible using a commercially available adapter. You can easily monitor operation status or perform control.

MEWTOCOL-COM

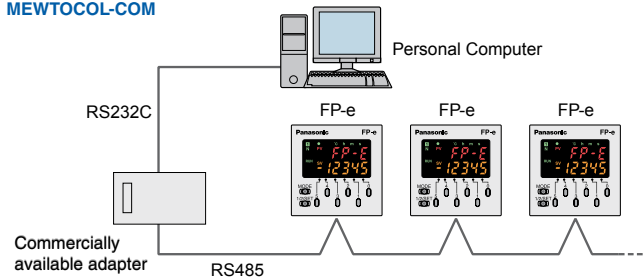

With RS232C, communication possible with up to two ports (RS232C type)

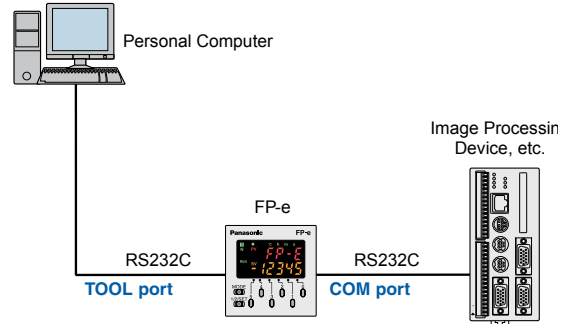

## Temperature control

Two-point K-type thermocouple (-30 to 300°C) connection possible (equipped with thermocouple input)

Can be used in place of a temperature controller or used to control them.

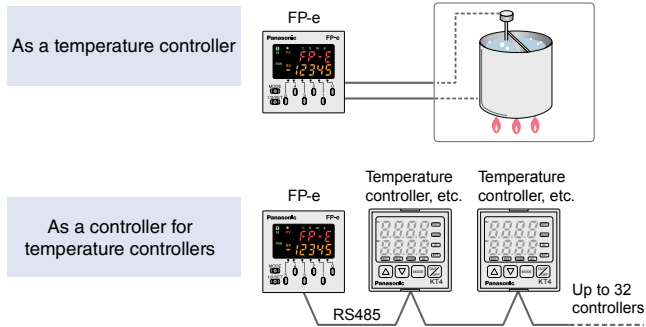

## PID instruction function

High-performance temperature control can be achieved with the PID instruction.

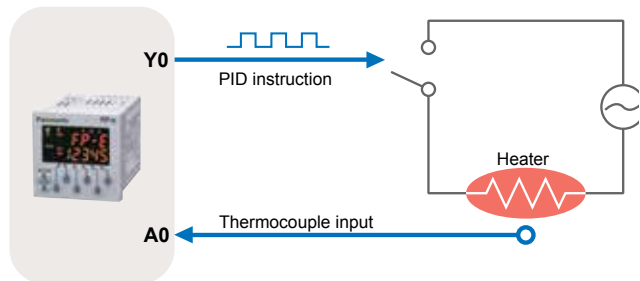

## High-speed counter for support of 2-axis independent positioning

### Pulse output function

The unit comes equipped with 2 channels for pulse output of up to 10kHz pulses. Since these two channels can be separately controlled, the FP-e is also suitable for 2-axis independent positioning.

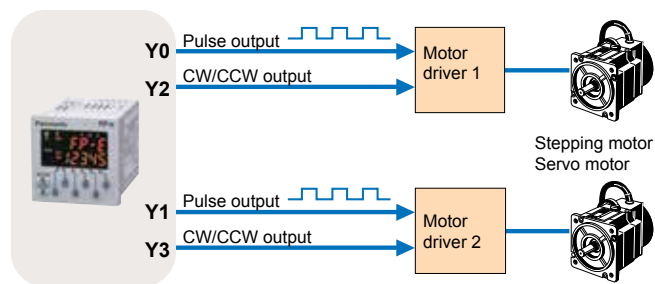

### High-speed counter function

In single phase, the 4-channel total is 10kHz, and in two-phase, the 2-channel total is 2kHz total speed, making the FP-e suitable for inverter control, etc. (One half for the type with thermocouple input.)

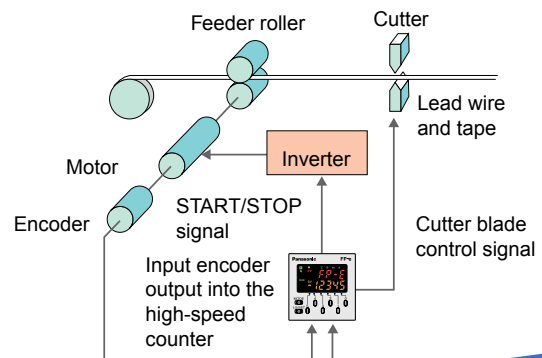

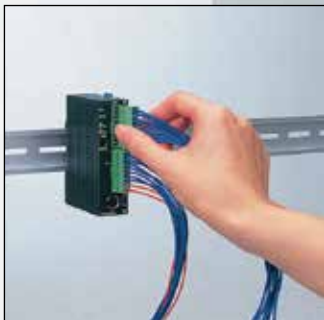

# FP0R series: The ultra-compact PLCs

## Features

- Ultra high-speed processing enhances productivity
- An ultra high-speed of 0.08μs/step for basic instructions for the first 3000 steps and 0.58μs/step thereafter. The FP0R is ideal for positioning and process automation applications, e.g. in labeling machines.
- Large programming capacity of 16k or 32k steps
- Generous data register of up to 12k or 32k words
- Independent comment memory for documenting purposes
- USB2.0 port provides high-speed program transfer
- The new F-type FP0R provides maintenance-free and complete backup of all data without requiring a battery. Industry's first!
- Highly advanced, built-in positioning functions for up to 4 axes (servo/stepping motor)
- Jog operation
- Individual settings for acceleration and deceleration for ramp functions
- Target speed can be changed by an external signal input during jog operation or trapezoidal control
- Can read encoder signals of up to 50kHz (pulse frequency measurement)
- 6-channel high-speed counters and 4-axis pulse outputs can be used simultaneously
- FP0R units provide various kinds of networking communication using a built-in interface or expansion units
- Ethernet (Modbus TCP/IEC 60870)
- Profibus
- CC-Link
- MEWNET-W0
- C-NET
- RS232C + RS484 serial communication
- FP0R – same ultra compact size as FP0
- FP0R – fully compatible with FP0 units



## Specifications

CPU type	C10 series (relay output)	C14 series (relay output)	C16 series (transistor output)	C32 series (transistor output)	T32 series (transistor output)	F32 series (transistor output)
Number of inputs	6	8	8	16	16	16
Number of outputs	4 relay	6 relay	8 NPN/PNP	16 NPN/PNP	16 NPN/PNP	16 NPN/PNP
Output capacity	2A	2A	0.2A	0.2A	0.2A	0.2A
Digital I/O (max.)	106	110	112	128	128	128
Internal relays (R)	4096					
Processing speed	Up to 3000 steps: 0.08μs/step (basic instruction) After 3000 steps: 0.58μs/step (basic instruction)					
Program memory	EEPROM (no back-up battery required)					
Program capacity	16,000 steps			32,000 steps		
Data register (DT)	12,315 words			32,765 words		
Memory backup (Flash ROM)	Backup with F12, P13 instruction for all areas					
	Auto backup when power is off: Counters: 16 Internal relays: 128 Data registers: 315 words					--
Memory backup (RAM)	--				Backup of the entire area by a built-in secondary battery	Backup of the entire area by FRAM (without the need for a battery)
High-speed counter	Single-phase: 6 channels (50kHz); 2-phase: 3 channels (15kHz)					
Pulse output	--	4 channels (50kHz), two channels can be controlled individually				
PWM output	--	4 channels (6Hz to 4.8kHz)				
RS232C interface	Up to two serial interfaces					
RS485 port	One RS485 port is mounted on each of C10MRS, C14MRS, C16MT, C16MP, C32MT, C32MP, T32MT, T32MP, F32MT, F32MP type (3P terminal block) Transmission speed (Baud rate): 19,200bits/s 115,200bits/s, Transmission distance: 1200m. Communication method: half-duplex					
Clock/calendar function	--				Available	--
Other functions	Online editing, 8-character password setting, and program upload protection					
Operating voltage	24V DC (± 10%)					

## A wide variety of both single and combined units

### CPU's

#### Relay output type



#### Transistor output type



10 points	
Input	Output
6 points	4 points
AFP0RC10RS AFP0RC10CRS with 2nd RS232C AFP0RC10MRS with RS485	

14 points	
Input	Output
8 points	6 points
AFP0RC14RS, AFP0RC14CRS with 2nd RS232C AFP0RC14MRS with RS485	

16 points	
Input	Output
8 points	8 points
AFP0RC16P (PNP), AFP0RC16T (NPN) AFP0RC16CP (PNP), AFP0RC16CT (NPN) with 2nd RS232C AFP0RC16MT, AFP0RC16MP with RS485	

32 points	
Input	Output
16 points	16 points
AFP0RC32P (PNP), AFP0RC32TC (NPN) AFP0RC32CP (PNP), AFP0RC32CT (NPN) with 2nd RS232C AFP0RC32MT, AFP0RC32MP with RS485	

32 points (T type)	
Input	Output
16 points	16 points
AFP0RT32CP (PNP), AFP0RT32CT (NPN) with 2nd RS232C AFP0RT32MT, AFP0RT32MP with RS485	

32 points (F type)	
Input	Output
16 points	16 points
AFP0RF32CP (PNP), AFP0RF32CT (NPN) with 2nd RS232C AFP0RF32MT AFP0RF32MP with RS485	

### FP Memory Loader

#### AFP8670

- Read or write programs (up to 60k steps) from or to a PLC
- Personal computer is not required
- Applicable with FP0R, FP-e, FPΣ (Sigma), FP-X and FP2SH



### S-LINK MASTER CPU

#### FP0-SL1

- Control of 64 input and 64 output points is possible with one unit
- Simple connection of S-LINK I/O devices
- Sensors can be easily connected with plug-in connections



### Up to three expansion units can be directly connected without connection cables

The expansion unit can be attached easily without any cables to the control unit. Special expansion cables, backplanes, and so forth, are unnecessary as the expansion unit employs a stacking system that uses expansion connectors and lock levers on the surface of the unit itself.

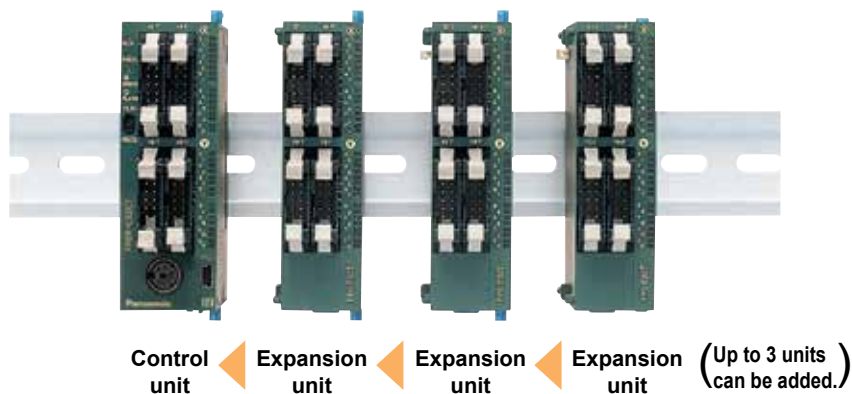



A maximum of 3 expansion units can be added to the control unit

## Digital I/O units

### Relay output type



8 points	
Input 4 points	Output 4 points
AFP0RE8RS	

16 points	
Input 8 points	Output 8 points
AFP0RE16RS	

32 points	
Input 16 points	Output 16 points
FP0-E32RS	

### Input only type



8 points	
Input 8 points	
AFP0RE8X	

16 points	
Input 16 points	
AFP0RE16X	

### Transistor output type



8 points	
Output 8 points	
AFP0RE8YP (PNP) AFP0RE8YT (NPN)	

16 points	
Input 8 points	Output 8 points
AFP0RE16P (PNP) AFP0RE16T (NPN)	

16 points	
Output 16 points	
AFP0RE16YP (PNP) AFP0RE16YT (NPN)	

32 points	
Input 16 points	Output 16 points
AFP0RE32P (PNP) AFP0RE32T (NPN)	

8 points	
Output 8 points	
AFP0RE8YRS	

## Analog I/O units



3 points	
Input 2 points	Output 1 point
FP0-A21	

4 points	
Output 4 points	
FP0-A04I	

4 points	
Output 4 points	
FP0-A04V	

8 points	
Input 8 points	
FP0-A80	

- Input (12 bit):  
± 10V, 0 – 5V,  
0 – 20mA
- Output (12 bit):  
± 10V, 0 – 20mA

–

± 10V

± 10V, ± 100mV  
0 – 5V, 0 – 20mA

–

## Temperature control units



4 points	
Input 4 points	
FP0-TC4	

8 points	
Input 8 points	
FP0-TC8	

6 points	
Input 6 points	
FP0-RTD6	

- K, J, T, R type thermocouples can be used
- Resolution: 0.1°C
- Accuracy: 0.8°C (R type: 3°C)
- Temperature range: -100 to 1500°C

- Pt100, Pt1000, Ni1000
- Temperature range: -200 to 500°C

## Networking units



**Ethernet**  
**FPWEB2**  
(Web-Server unit)  
**FPWEBEX**  
(Web-Expansion)

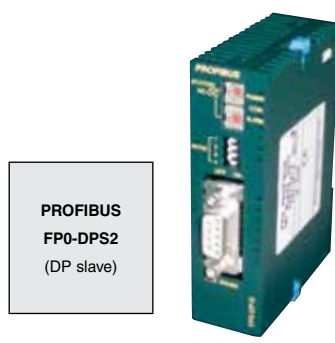

**PROFIBUS**  
**FP0-DPS2**  
(DP slave)



**FP Modem-56k**  
(FP analog modem)

## Add-on unit

### Switch 2A loads within the network

Switch electrically insulated loads of 250V AC reliably using the FP0R Relay Terminal FP0-RT8Y-6A directly within the network.



Switch electrically insulated loads of 250V AC reliably using the FP0R relay terminal FP0-RT8Y-6A directly within the network.

Many more connection products are available, please refer to the “Panasonic connection technology for PLC” catalog.

### The ultra-high processing speed is also ideal for use as a sensor controller

Labeling machines, for example, require a system capable of instantly reading output signals from a fiber sensor and quickly controlling the roller rotation to detect the label head or end edge on the release paper tape taken up at a high-speed.

Ultra-high-speed scanning by FP0R:

- 100 program steps: max. 0.2ms
- Even 1000 program steps: max. 0.5ms
- FP0R can serve well as a high performance sensor controller in combination with a Panasonic fiber sensor

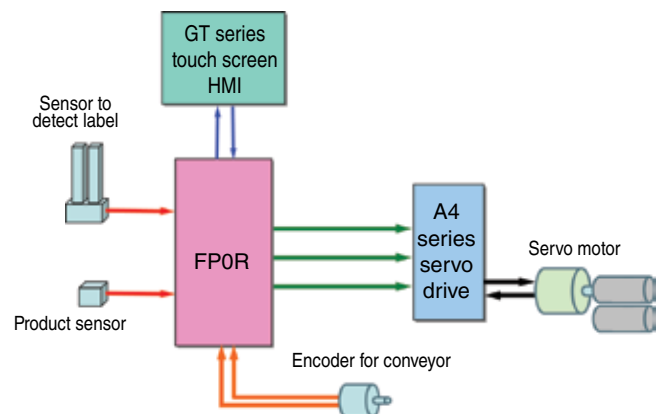
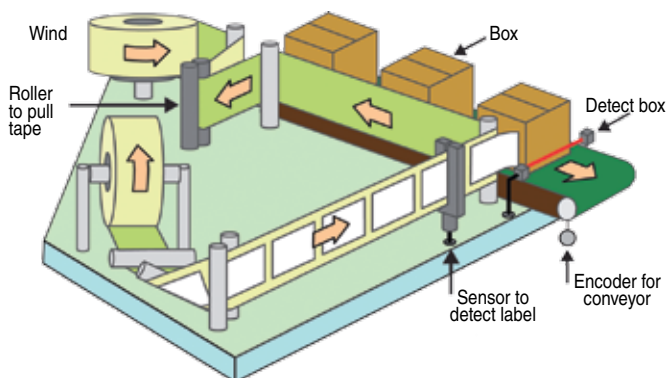

- Encoder input speed is 20,000 pulses per second.
- 10 pulses after the product sensor is triggered, motion is executed.
- 35ms after motion starts, the falling edge of the label is detected.
- Motion continues for another 200 command pulses from the FP0R.
- The complete cycle for applying one label takes 50ms.

# FP0R positioning

## Jog positioning control (F171 instruction)

Motion can be started without a preset target value. When a stop signal is input, the target value is set, and the motion is slowed to a stop.

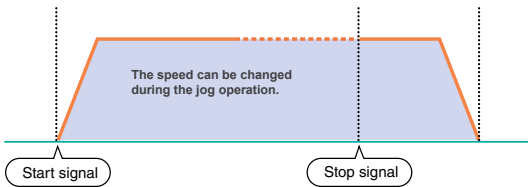

- Useful for**
- Labels: Stopping the motion at a constant distance from the point where a label end detection signal is triggered
  - Processing machines: Stopping the motion at a constant distance from the point where a processing object edge detection signal is triggered, and cut/drill the object

## Individual settings for acceleration and deceleration (F171, F172, F174, and F175 instructions)

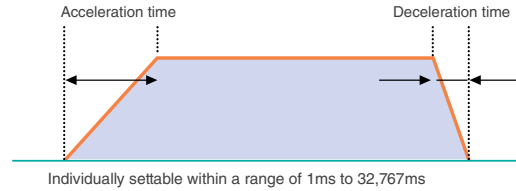

- Useful for**
- Labels: Starting the operation at a relatively low acceleration to prevent tape from breaking
  - Stopping the operation at high deceleration when detecting the label end to save the tape

## Changing the speed (F171 and F172 instructions)

The target speed can be changed by an external signal input during the jog or trapezoidal control operation.

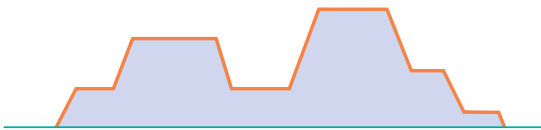

- Useful for**
- Speed synchronization of transfer/processing equipment

## Measuring the pulse frequency (F178 instruction)

Pulses input in a specified period by a single instruction are counted, and the frequency is calculated.

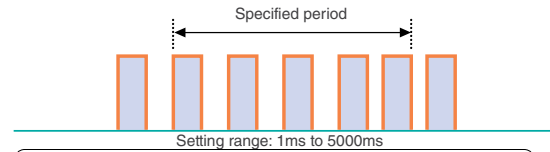

- Useful for**
- Detection of motor rotation speed for encoder feedback control

## Built-in 4-axis pulse outputs (Transistor output type)

Multi-axis (4-axis) control is available without expansion units.

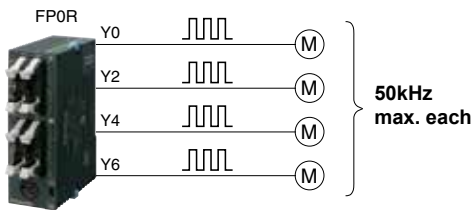

Two sets can simultaneously undergo two-axis linear interpolation (F175 instruction).

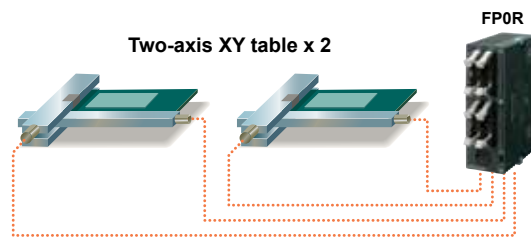

## Simultaneously usable high-speed counters (6 channels) and pulse outputs (4 channels)

The speed of conveyor 1, which is inverter-controlled, is measured based on the encoder pulse count, and pulses are output to the slave motor (for jog operation) according to the measured speed in order to synchronize the speed of conveyor 2.

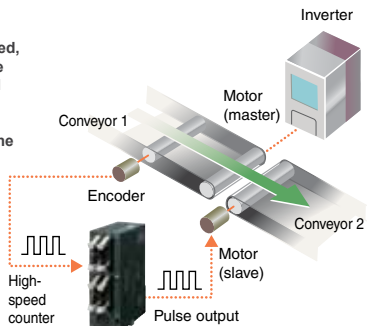

## Built-in multipoint PWM outputs (4 channels)

A single FP0R unit can control the speeds of up to six DC motors/fan motors. It also can serve as an analog voltage output unit.

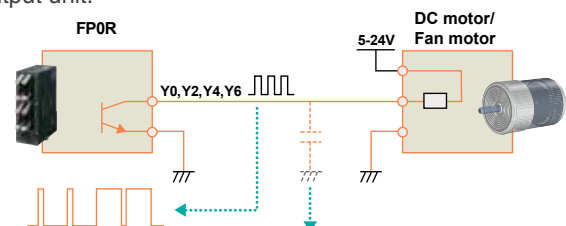

The speed can be controlled by changing the ON width of the PWM output within a range of 0.1% to 99.9%.

The unit can also serve as an analog voltage output unit (resolution: 1/1000) when a smoothing capacitor is inserted in the circuit.

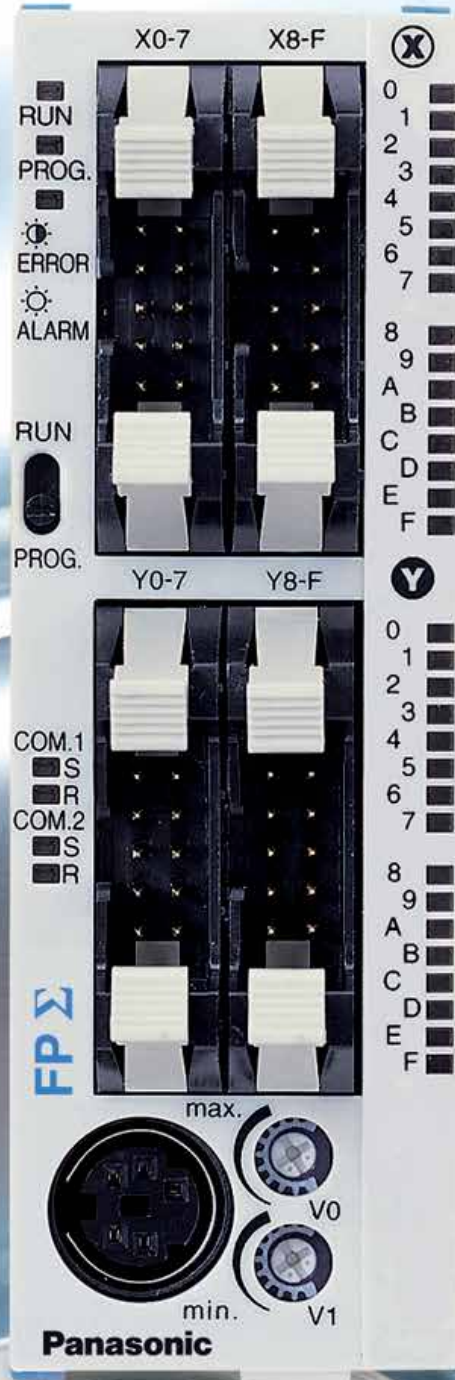

# FPΣ (Sigma): The next generation compact PLC

## Features

- Abundant program capacity – 32k steps
- The 32k step program capacity can accommodate an increase in the number of programs accompanying functionality enhancements, expansions, or changes of equipment.
- Equipped with an independent comment memory
- All of 100,000 I/O comments, 5000 lines of line-space comments, and 5000 lines of remark comments are saved in FPΣ (Sigma) together with programs.
- Equipped with a high-speed RISC processor
- Equipped with an RISC processor, achieving high-speed processing with a scan time of less than 2ms for 5000 steps.
- High-speed positioning unit  
The 4Mpps maximum frequency and startup speed of 0.005ms allow use for linear servo control.
- Simple temperature control  
A temperature control program can be written in only one line by using the PID F356 (EZPID) instruction, facilitating temperature control by a PLC, which had previously been considered difficult.



## Specifications

Model		FPG-C32T2H FPG-C32T2HTM	FPG-C24R2H FPG-C24R2HTM	FPG-C28P2H FPG-C28P2HTM
Number of I/O points	Control unit	32 points (DC input: 16, NPN output: 16)	24 points (DC input: 16, relay output: 8)	28 points (DC input: 16, PNP output: 12)
	With FP0R expansion units	Max. 128 points (up to 3 units) when using transistor output type expansion units	Max. 120 points (up to 3 units) when using transistor output type expansion units	Max. 124 points (up to 3 units) when using transistor output type expansion units
	With FPΣ (Sigma) expansion units	Max. 288 points (up to 4 units) when using transistor output type expansion units	Max. 280 points (up to 4 units) when using transistor output type expansion units	Max. 284 points (up to 4 units) when using NPN output type expansion units
	With FP0R and FPΣ (Sigma) expansion units	Max. 384 points when using transistor output type expansion units	Max. 376 points when using transistor output type expansion units	Max. 380 points when using NPN output type expansion units
Programming method/ Control method		Relay symbol/cyclic operation		
Program memory		Built-in flash ROM (without backup battery)		
Program capacity		32k steps		
Number of instructions	Basic	93		
	High-speed	218	216	218
Operation speed		Basic instruction: 0.32μs/step (32k type)		
Operation memory points	Relay	Internal relays (R)	4096 points (32k type): R0 to R255F	
		Timers/counters (T/C)	1024 points <sup>1)2)</sup> (factory settings: timers: 1008 points (T0 to T1007), counters: 16 points (C1008 to C1023) Timer: counts in units of up to 32,767 times (units: 1ms, 10ms, 100ms, or 1s). Counter: Counts 1 to 32,767	
	Memory area	Link relays (L)	2048 points (32k type)	
		Data registers (DT)	32,765 words (DT0 to DT32764) <sup>1)</sup>	
		Link data registers (LD)	256 words (32k type)	
		Index registers (IX,IY)	14 words (I0 to ID)	
Master Control Relay points (MCR)		256		
Labels (JMP + LOOP)		256		
Differential points		Unlimited		
Number of step ladder		1000 stages		
Number of subroutines		100		
Pulse catch input		8 points (X0 to X7)		
Interrupt program		9 programs (8 external input points (X0 to X7), 1 periodical interrupt point 0.5ms to 30s)		
Self-diagnostic function		E. g. watchdog timer, program syntax check		
Clock/calendar function		Available (year, month, day, hour, minute, second and day of week); however, this function can only be used when a battery has been installed <sup>3)</sup> .		
Potentiometer (Volume) input		2 points, resolution: 10 bits (0 to 1000)		
Battery life		220 days or more (actual usage value: approx. 840 days (25°C). Suggested replacement interval: 1 year. Value applies when no power at all is supplied.		
Comment storage		All kinds of comments, including I/O comments, remarks and block comments, can be stored (without backup battery).		
Link function		MEWTOCOL-COM (1:1, 1:N) <sup>4)</sup> Program controlled (1:1, 1:N) <sup>4)5)</sup> PLC Link <sup>6)</sup>		
Other functions		Online editing, constant scan, forced on/off, password, floating-point operation and PID processing		
Linear/circular interpolation for positioning		Available	Not available	Available

Notes: 1) If no battery is used, only the fixed area is backed up (counters 16 points: C1008 to C1023, internal relays 128 points: R900 to R97F, data registers 55 words: DT32710 to DT32764). When the optional battery is used, hold-type data can be backed up. Areas to be held and not held can be specified using the system registers.  
2) The number of points can be increased by using an auxiliary timer.  
3) Precision of clock/calendar function:  
- At 0°C 32°F, less than 119 seconds error per month.  
- At 25°C, less than 51 seconds error per month.  
- At 55°C, less than 148 seconds error per month.

4) An optional communication cassette (RS232C type) is required in order to use 1:1 communication.  
5) An optional communication cassette (RS485 type) is required in order to use 1:N communication.  
6) An optional communication cassette (RS485 type) is required. The number of points actually available for use is determined by the hardware configuration.

## Control units: Outstanding performance in a compact design

FPΣ – Transistor output type



28 points	
Input 16 points	Output PNP 12 points
MIL connector type FPG-C28P2H	



32 points	
Input 16 points	Output NPN 16 points
MIL connector type FPG-C32T2H	

FPΣ – Relay output type



24 points	
Input 16 points	Output relay 8 points
Screw terminal type FPG-C24R2H	

FPΣ – Transistor output type with thermistor input



28 points	
Input 16 points	Output PNP 12 points
2 thermistor inputs FPG-C28P2HTM	



32 points	
Input 16 points	Output NPN 16 points
2 thermistor inputs FPG-C32T2HTM	

FPΣ – Relay output type with thermistor input



24 points	
Input 16 points	Output relay 8 points
2 thermistor inputs FPG-C24R2HTM	

### High expansion capability

FPΣ can use the expansion units of the FP0R on the right-hand side. FPΣ units can be added to the left hand side.

Max. 4 expansion units  
each 64 I/Os = 256 I/Os

...up to 384 I/O!

Control unit  
max. 32 I/Os

Max. 3 expansion units  
each 32 I/Os = 96 I/Os



Parallel  
expansion  
bus



Serial  
expansion  
bus

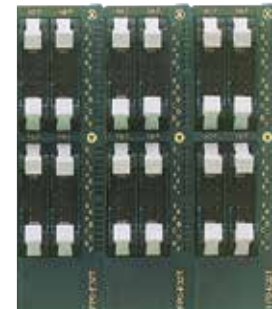

# Expansion units: Wide variety – left side

**FPΣ**  
I/O expansion unit



64 points	
Input 32 points	Output (PNP) 32 points
MIL connector type FPG-XY64D2P	

**FPΣ**  
I/O expansion unit



64 points	
Input 32 points	Output (NPN) 32 points
MIL connector type FPG-XY64D2T	

**FPΣ**  
Memory expansion unit



FPG-EM1
Memory: 256k words
FPG-EM1

**FPΣ**  
Analog unit



8 points	
Input 4 points	Output 4 points
MIL connector type FPGAD44D50 (with 50Ω) FPGAD44D250 (with 250Ω)	

- Input (16 bit):  
0–10V, 0–20mA
- Output (12 bit):  
0–10V, ±10V,  
4–20mA

## FPΣ positioning expansion units RTEX Real-time Ethernet system for MINAS A5N servo drives



2-axis
FPG-PN2AN



4-axis
FPG-PN4AN



8-axis
FPG-PN8AN

## FPΣ positioning expansion units



1-axis
Transistor output FPG-PP11



1-axis
Line driver output FPG-PP12



2-axis
Transistor output FPG-PP21



2-axis
Line driver output FPG-PP22

## Specially designed for positioning application

**Max. 100kHz pulse output performance is now standard.**  
**Powerful device capable of linear interpolation and circular interpolation.**

### Pulse output max. 100kHz

Because command processing at speeds up to 100kHz is available, high-speed, high-precision positioning is enabled. Along with stepping motor control, the specs also ensure plenty of scope for controlling servo motors.

Possible to combine with pulse-train input drivers.  
 Single unit enables two-axis control.

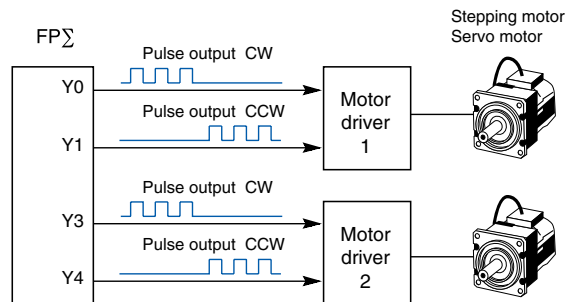

### Rapid 0.02ms start (when JOG operation controls are executed)

The time taken to execute the JOG operation, from the instant the trigger (execution condition) goes on to the time of pulse output, is 0.02ms and 0.2ms even with trapezoidal control. Control time is reduced even for machines that quickly and repeatedly restart.

### Linear interpolation and circular interpolation are built-in (FPG-C32T2H-A and FPG-C28P2H-A)

Interpolation functions enable simultaneous control of two axes. Applications that a compact PLC couldn't previously cope with are no longer a challenge.

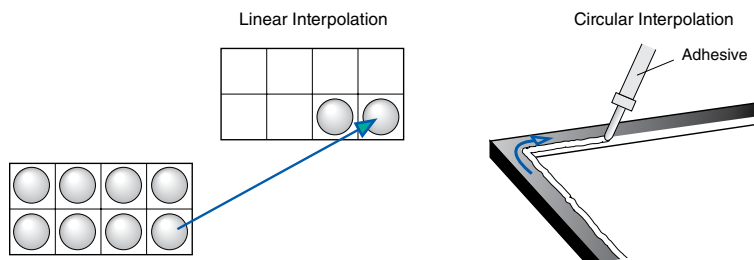

### And there's more:

#### **Smooth acceleration/deceleration**

You can choose to set either 30 or 60 steps of acceleration/deceleration. This feature means you can achieve smoother movement during long acceleration/ deceleration periods of stepping motors.

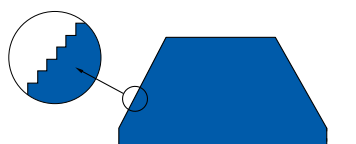

#### **Support for CW/CCW method**

Reduce overall costs by designing systems that combine with servo motors and small stepping motors without support for Pulse and Sign method.

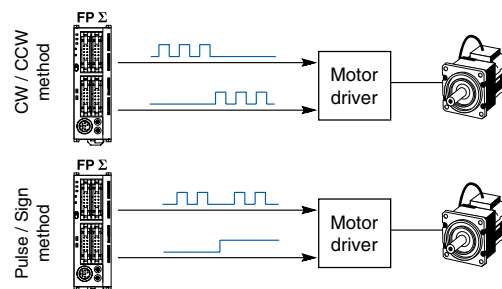



# High-speed, high-precision positioning

## Programming with convenient and easy-to-understand instructions

- Uses a preset value table for starting speed, target speed, acceleration/deceleration time, and other factors. Easy-to-understand programming is possible since numbers can be specified intuitively.
- Comes with dedicated instructions for each mode: trapezoidal control, home return, JOG operation, free table operation, linear interpolation and circular interpolation.

## Selectable home return mode

- The home return method may be specified even in situations such as when only a single sensor is being used, depending on the design.
- When the home position return is completed, a deviation counter clear signal can also be output.

## Home position return

- Pulse output diagram (when the near home input is not used).

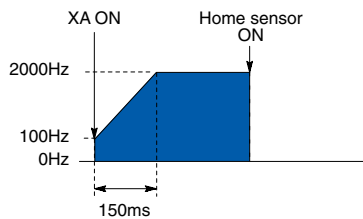

Home search automatically reverses the motor rotation when the positive or negative limit switch is reached and searches for the home position or near home position.

## JOG operation

- Pulse output diagram.

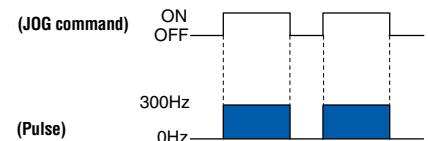

This refers to an operation in which the motor is rotated only while operation commands are being input. This is used to forcibly rotate the motor using input from an external switch, for instance when making adjustments. Depending on the circumstances, unlimited feeding can be accomplished with the JOG operation.

## Linear interpolation

- Positioning locus.

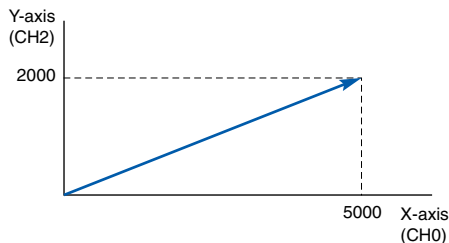

A control function that automatically defines the continuum of points in a straight line based on only two coordinate positions.

## Circular interpolation

- Positioning locus.
- Pass and center position methods are available.

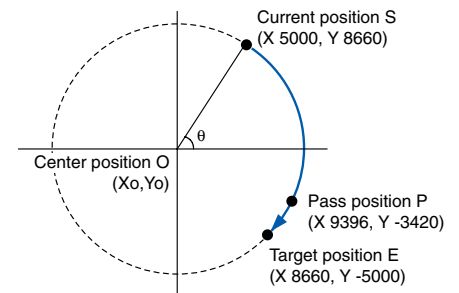

Allows points to be smoothly traversed by arced paths for which the user specifies the orientation plane, the radius of curvature, motion path profile and direction of motion.

## Precise positioning

### Features

- Fast startup of 0.02 or 0.005ms makes cycle time reduction possible.
- Feedback pulse count function makes output pulse counting from external encoders possible.
- JOG positioning control supports a wide range of applications.
- 4 types of S-curve acceleration/deceleration control makes smooth startup and stopping possible:  
Sine curve, quadratic curve, cycloid curve and cubic curve.



FPG-PP11



FPG-PP12



FPG-PP21



FPG-PP22

- The FPΣ (Sigma) positioning unit can handle simultaneous startup of multiple axes, enabling simultaneous control of linear interpolation and other elements through user programs.
- Transistor output type (open collector) and line driver output type are available.

Unit type and part number		
Type	Output type	Part number
1-axis type	Transistor output type	FPG-PP11
2-axis type	Transistor output type	FPG-PP21
1-axis type	Line driver output type	FPG-PP12
2-axis type	Line driver output type	FPG-PP22

### Positioning control using a stepping motor

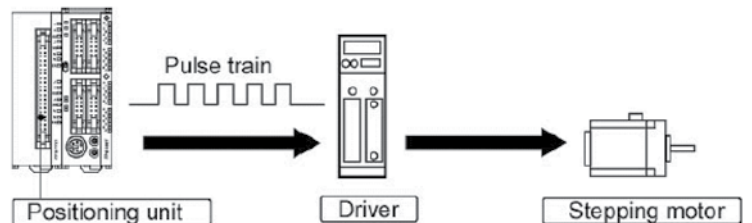

### Positioning control using a servo motor

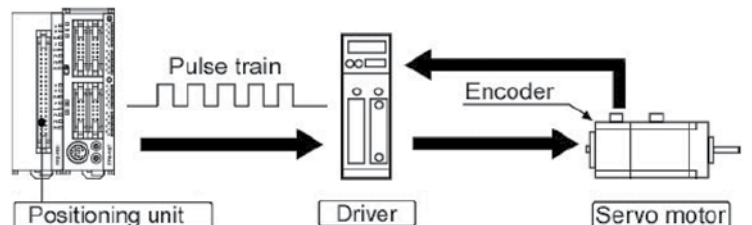

**1-axis and 2-axis types are available.**

Multiple axes (up to 2 axes) can be controlled with a single unit.

# RTEX multi-axis network servo system

The RTEX (RTEX = Panasonic Realtime Express) positioning units support MINAS A4N and MINAS A5N network servo drives. A mutually optimized system consisting of PLC and servo drive greatly simplifies installation.

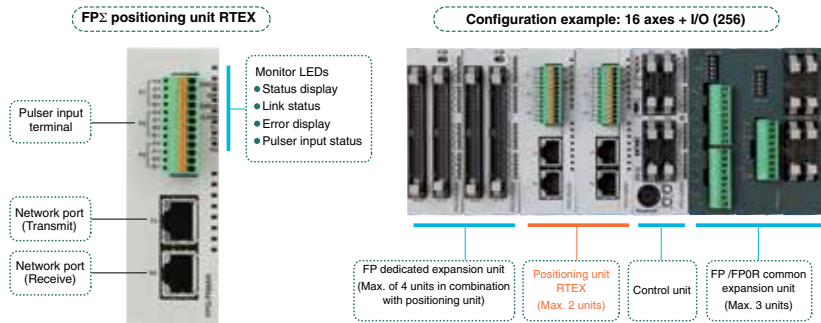

## System configuration:

- Maximum number of control axes: 16. Realization of highly accurate 2-axis circular interpolation, 3-axis linear interpolation and 3-axis spiral interpolation with high-speed 100Mpps communication.
- With 3 types in the product range, for 2 axes, 4 axes and 8 axes provide flexible support even for control of small numbers of axes.
- Loop wiring RTEX provides high reliability by creating smooth communication conditions in which data always flows in the same direction.

## Specifications:

Type		2-axis type	4-axis type	8-axis type
Part number FPΣ (Sigma)		FPG-PN2AN	FPG-PN4AN	FPG-PN8AN
Unit specifications	Positioning control functions	Control method	PTP Control, continuous path (CP) control	
		Interpolation control	2-axis/3-axis linear interpolation, 2-axis circular interpolation, 3-axis spiral interpolation	
		Control units	Pulse/μm/inch/degree	
		Position data	600 points for each axis	
		Backup	Parameters and data file can be saved to FROM	
		Acceleration/deceleration method	Linear acceleration/deceleration/S-curve acceleration/deceleration	
		Acceleration/deceleration time	0 to 10,000ms (1ms units) different settings for acceleration and deceleration are possible	
		Positioning area	(-1,073,741,823 to 1,073,741,823 pulse) increment and absolute specification	
	Speed control functions	Supported with JOG operation (free run operation)		
	Origin functions	Search method	Origin proximity (DOG) search	
		Creep speed	Free settings possible	
Other functions		Pulser input operation support		
		Auxiliary output code, auxiliary output contact support		
		Dwell time support		
Communication specifications	Communication speed	100Mbit/s		
	Cable	Commercially available LAN straight cable (shielded category 5e)		
	Connection method	Ring method		
	Communication cycle/no. of terminals	0.5ms; max. 8 axes/system (command cycle: 1ms)		
	Transmission distance	Between terminals: 60m; total length: 200m		



# FP-X series: An advanced compact model

## Features

- Abundant program capacity – 32k steps  
The 32k-step program capacity can accommodate an increase in the number of programs accompanying functionality enhancements, expansions, or changes of equipment.
- Equipped with an independent comment memory The FP-X series offers sufficient comment memory to enable saving the PLC program created according to IEC 61131, including all comments.
- Equipped with a high-speed RISC processor  
Equipped with a RISC processor, achieving high-speed processing with a scan time of less than 2ms for 5000 steps
- Add-on cassettes can expand the functionality, maintaining the space-saving size  
Up to three add-on cassettes can be attached to the control unit. Functionality can be enhanced without increasing the required footprint. The 16 types of add-on cassettes, including the communication and analog types, cover a wide variety of applications.
- Multi-axis control by the built-in pulse output  
The transistor output type controller has a built-in pulse output that allows multi-axis control of the servo and stepping motors.  
C14: 3 axes, C30/C60: 4 axes.



**High security:** program protection with an 8-digit password and a function prohibiting uploads

**USB-port (C30/C60):** easy direct connection with a PC via a commercial USB cable (AB type)

## Specifications

PLC type		AFPX-C14	AFPX-C30	AFPX-C38AT	AFPX-C60	
Number of inputs		8	16	24 digital/4 analog	32	
Number of outputs		6 relays or transistors	14 relays or transistors	14 digital /2 analog	28 relays or transistors	
Max. number of digital I/Os		328	352	360	382	
Max. number of analog I/Os		26	28			
Processing speed		0.32μs/step (basic instruction)				
Memory	Memory type	Built-in Flash ROM				
	Program capacity	16k steps	32k steps			
	Data register	12,285 words	32,765 words			
Special functions	High-speed counter	Transistor output types: Single-phase 8ch (50kHz x 4ch + 10kHz x 4ch), Two-phase 4ch (35kHz x 1ch, 25kHz x 1ch, 5kHz x 2ch) Relay output types: Single-phase 8ch (10kHz x 8ch), Two-phase 4ch (5kHz x 4ch)				
	Pulse output	Pulse I/O cassette AFPX-PLS (for relay output types): Single-phase: 2 channels 80kHz or 4 channels 50kHz Two-phase: 1 channel: 30kHz or 2 channels: 25kHz  Built-in transistor outputs: 100kHz x 2ch + 20kHz x 2ch Pulse I/O cassette AFPX-PLS (for relay output types only): One unit (one axis) 100kHz, or two units (two axes) 80kHz				
	Serial communication	Up to 3 serial interfaces, C30/C60 also USB port				
	Clock/calendar function	Available when AFPX-MRTC is installed.		Built in		Available when AFPX-MRTC is installed.
	Other functions	Password (4 digits, 8 digits), upload protection, comment storage (32kByte)				
	Operating voltage range	85 to 264V AC (AC power), 20.4 to 28.8V DC (DC power)				

## High adaptability

### Add the cassettes you need to meet your individual needs

The add-on cassettes can easily be mounted onto the control unit, up to 2 cassettes on the C14 or 3 cassettes on the C30/C60. By using one communication cassette, which can be stacked on top of another expansion cassette, even the FP-X's communication can be expanded.



Easily removable  
(two screws secure the unit)

### Built-in 4-axis pulse output: 2-axis linear interpolation simultaneously in two sets

The transistor output type C14 comes with 3-axis while C30/60 comes with 4-axis pulse output inside the control unit. The multi-axis control, which previously required a higher-level PLC or additional positioning unit, or two or more PLC units, can now be achieved with only one FP-X transistor output type unit in a small space at a low cost.

FP-X transistor output type is capable of simultaneously controlling 2-axis linear interpolation, for the first time in the industry with a compact pulse-output PLC.

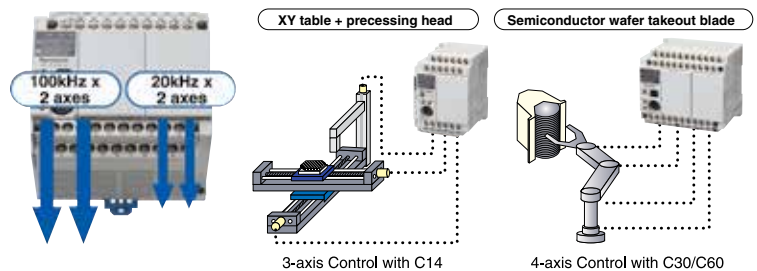

### Easy program transfer with master memory cassette, real-time clock included

- The built-in 1MB Flash-ROM can store a 32k-step program as well as the comments of FPWIN Pro source file.
- The master memory cassette allows you to conveniently update a program on an FP-X in the field.
- Because the master memory cassette can store password information, you can easily enjoy all the security features the FP-X offers even when transferring programs in the field.
- The built-in real-time clock enables repeated periodical control and data logging.

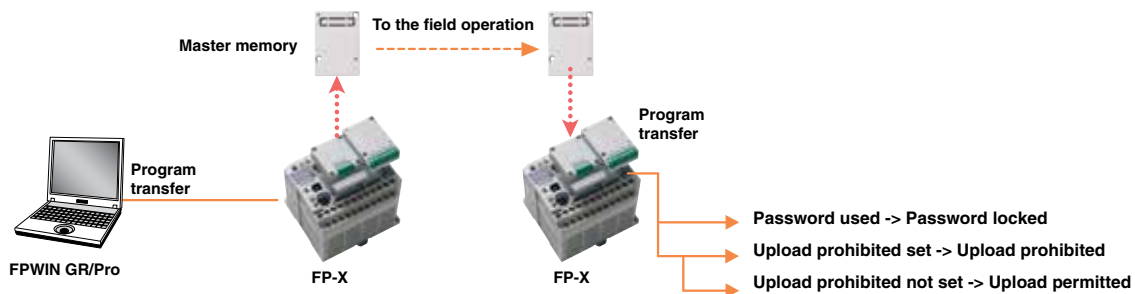

### Expensive USB conversion adapter/cable unnecessary



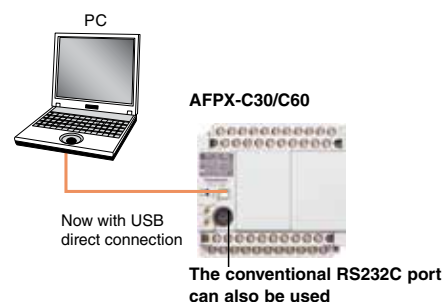

Now you can connect your PC directly to the FP-X C30's or C60's USB port.





# Product lineup

## The highly expandable lineup satisfies a wide range of demands



### CPU



CPU	Relay output		Transistor output	
	DC power supply	AC power supply	DC power supply	AC power supply
 Program capacity: 16k steps 2-point potentiometer	<b>AFPX-C14RD</b> 8-point input of 24V DC 6-point output of 2A relay	<b>AFPX-C14R</b> 8-point input of 24V DC 6-point output of 2A relay	<b>AFPX-C14TD (NPN)</b> <b>AFPX-C14PD (PNP)</b> 8-point input of 24V DC 0.5A/5 to 24V DC 6-point output of transistor	<b>AFPX-C14T (NPN)</b> <b>AFPX-C14P (PNP)</b> 8-point input of 24V DC 0.5A/5 to 24V DC 6-point output of transistor
 Program capacity: 32k steps 2-point potentiometer, equipped with a USB communication port	<b>AFPX-C30RD</b> 16-point input of 24V DC 14-point output of 2A relay	<b>AFPX-C30R</b> 16-point input of 24V DC 14-point output of 2A relay	<b>AFPX-C30TD (NPN)</b> <b>AFPX-C30PD (PNP)</b> 16-point input of 24V DC 0.5A/5 to 24V DC 14-point output of transistor	<b>AFPX-C30T (NPN)</b> <b>AFPX-C30P (PNP)</b> 16-point input of 24V DC 0.5A/5 to 24V DC 14-point output of transistor
 Program capacity: 32k steps 4-point potentiometer, equipped with a USB communication port	<b>AFPX-C38AT</b> 24-point input of 24V DC + 4 analog inputs 0.5A/5 to 24V DC 14-point output of transistor (NPN) + 2 analog outputs			
 Program capacity: 32k steps 4-point potentiometer, equipped with a USB communication port	<b>AFPX-C60RD</b> 32-point input of 24V DC 28-point output of 2A relay	<b>AFPX-C60R</b> 32-point input of 24V DC 28-point output of 2A relay	<b>AFPX-C60TD (NPN)</b> <b>AFPX-C60PD (PNP)</b> 32-point input of 24V DC 0.5A/5 to 24V DC 28-point output of transistor	<b>AFPX-C60T (NPN)</b> <b>AFPX-C60P (PNP)</b> 32-point input of 24V DC 0.5A/5 to 24V DC 28-point output of transistor

### Expansion units

Expansion unit	Relay output		Transistor output	
	DC power supply	AC power supply	DC power supply	AC power supply
 Remarks: 2 or more E14s and E16s cannot be connected serially because they cannot supply the power to other units.	<b>AFPX-E16R</b> 8-point input of 24V DC 8-point output of 2A relay	<b>AFPX-E14YR</b> 14-point output of 2A relay	<b>AFPX-E16T (NPN)</b> <b>AFPX-E16P (PNP)</b> 8-point input of 24V DC 0.5A/5 to 24V DC 8-point output of transistor	
 Remarks: Addition of up to 8 units is possible including E16 and EFP0.	<b>AFPX-E30RD</b> 16-point input of 24V DC 14-point output of 2A relay	<b>AFPX-E30R</b> 16-point input of 24V DC 14-point output of 2A relay	<b>AFPX-E30TD (NPN)</b> <b>AFPX-E30PD (PNP)</b> 16-point input of 24V DC 0.5A/5 to 24V DC 14-point output of transistor	<b>AFPX-E30T (NPN)</b> <b>AFPX-E30P (PNP)</b> 16-point input of 24V DC 0.5A/5 to 24V DC 14-point output of transistor
	<b>AFPX-E16X (16-point input only)</b> 16-point input of 24V DC.			

### Add-on cassettes

Application cassette	Application cassettes	
	Part number	Description
	<b>AFPX-IN4T3</b>	Input/output cassette (4-point input of 24V DC, NPN 0.3A/3-point output of 24V DC)
	<b>AFPX-IN8</b>	Input cassette (8-point input of 24V DC)
	<b>AFPX-TR8</b>	Output cassette (NPN 0.3A/8-point output of 24V DC)
	<b>AFPX-TR6P</b>	Output cassette (PNP 0.5A/6-point output of 24V DC)
	<b>AFPX-PLS</b>	Pulse I/O cassette (relay output type only): High-speed counter input: single phase 80kHz 2ch, 2-phase 30kHz 1ch Pulse output: 100kHz 1ch, 25kHz 2ch, 50kHz 4ch, CW/CCW, pulse + sign
	<b>AFPX-AD2</b>	Analog input cassette (2 points, 0 to 10 V/0 to 20mA 12-bit non-insulated)
	<b>AFPX-A21</b>	Analog I/O cassette Input: 2ch (0 to 5V/0 to 10V or 0 to 20mA 12-bit insulated) Output: 1ch (0 to 10V or 0 to 20mA 12-bit insulated)
	<b>AFPX-DA2</b>	Analog output cassette 2ch (0 to 10V or 0 to 20mA 12-bit insulated 2ch)
	<b>AFPX-TC2</b>	Thermocouple cassette (K/J type, resolution: 0.2°C, insulated)
	<b>AFPX-RTD2</b>	RTD input with 2 channels (insulated)
	<b>AFPX-MRTC</b>	Master memory cassette with clock/calendar function (battery required, (32k-steps program memory + real-time clock in year/month/day/hour/minute)

Communication cassette	Communication cassettes	
	Part number	Description
	<b>AFPX-COM1</b>	Communication cassette (1-channel RS232C)
	<b>AFPX-COM2</b>	Communication cassette (2-channel RS232C)
	<b>AFPX-COM3</b>	Communication cassette (1-channel RS485/422 type)
	<b>AFPX-COM4</b>	Communication cassette (1-channel RS485 and 1-channel RS232C combination type)
	<b>AFPX-COM5</b>	Communication cassette (1-channel Ethernet + 1-channel RS232C type)
	<b>AFPX-COM6</b>	Communication cassette (2-channel RS485 2ch)

### Expansion FP0 adapter

Expansion FP0 adapter	Part number	Description
		<b>AFPX-EFP0</b>

## Add-on cassette for Ethernet

This easy-to-mount communication cassette for Ethernet is suitable for flexible solutions when it comes to collecting inspection and production data and ensuring traceability as well as providing remote access to PLCs, e.g. to update the PLC program.

AFPX-COM5



Enables easy Ethernet connections with a compact PLC, which were previously not possible. Also equipped with an RS232C port. Together with the tool port (programming port), a total of 3 communication ports are available, which is remarkable for a compact PLC.

For example, the following operations are simultaneously available with this cassette attached:

1. I/O control
2. Reading data from a tester (measuring instrument) of inspection equipment (RS232C)
3. Collecting read data from host computer (Ethernet)
4. Setting/monitoring via a touch panel (TOOL port)

### Application

- Data collection

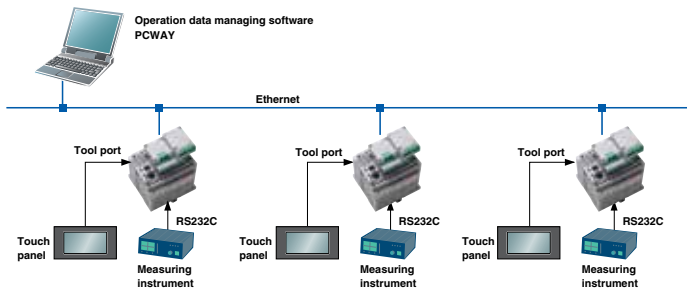

- Remote maintenance
- Program / monitoring

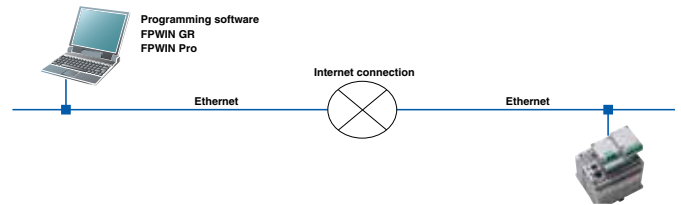

Interface	Specifications and functions
Ethernet (COM1)	10BASE-T, 100BASE-TX, TCP/IP, baud rate: 9600bit/s/115,200bit/s
RS232C (COM2)	

Ethernet port functions		Specifications
MEWTOCOL-COM master/slave		<ul style="list-style-type: none"> <li>• Automatically sends responses without communication programs to commands of Panasonic's open protocol MEWTOCOL.</li> <li>• Contact/word data writing/reading, program editing</li> <li>• PCWAY, FPWIN GR and Control FPWIN Pro are supported</li> </ul>
Program-controlled communication	Server function	• Waits for a connection from a client PC (personal computer), and after the connection has been established, receives data from the PC
	Client function	• After the power has been turned on, establishes a connection to a preset IP address and sends data

Use our free software Configurator WD for setting up the Ethernet port (e.g. IP address and operation mode).

Download the software free of charge from:  
[www.panasonic-electric-works.com](http://www.panasonic-electric-works.com)





# Positioning with the FP-X

## For low cost multi-axis positioning control

### Built-in 4-axis pulse output: 2-axis linear interpolation simultaneously in two sets

The transistor output type C14 comes with 3-axis while C30/60 comes with 4-axis pulse output inside the control unit. The multi-axis control, which previously required a higher-level PLC or additional positioning unit, or two or more PLC units, can now be achieved with only one FP-X transistor output type unit in a small space at a low cost. In addition, as this type does not require a pulse I/O cassette as needed for a relay output type, other function expansion cassettes such as communication or analog input can be attached for more diversified applications.

Item	Specification
Max. output frequency	C14: 100kHz(CH0,1), 20kHz(CH2) C30, C60: 100kHz(CH0,1), 20kHz(CH2,3)
Output type	CW/CCW, Pulse + Direction Output
Function	Trapezoidal control, table shaped control, jog operation, home return, 2-axis linear interpolation

#### XY table + processing head

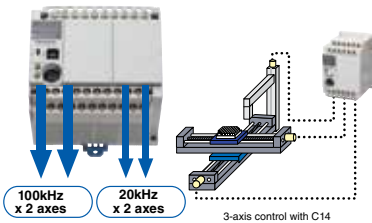

#### Semiconductor wafer takeout blade

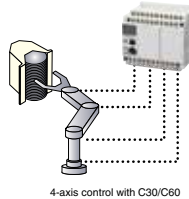

#### 2-axis control with expansion cassettes (relay output types only)

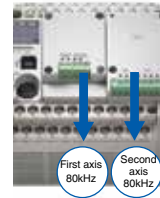

Pulse output up to 2-axis 80kHz is possible by loading 2 pulse I/O cassettes (AFPX-PLS). Also capable of performing 2-axis linear interpolation.

### 2-axis linear interpolation simultaneously in 2 sets (transistor output type)

2-axis linear interpolation refers to moving a robot arm or equipment head diagonally on a straight line by simultaneously controlling 2 motor shafts. It is used for palletizing, component pick and place, XY table control, contour cutting of a PC board, etc. The FP-X transistor output type is capable of simultaneously controlling 2-axis linear interpolation, for the first time in the industry with a compact pulse-output PLC. This unit dramatically expands the range of applications along with the added convenience of programming by using the linear interpolation command F175\_PulseOutput\_Linear.

#### Simultaneous control of 2 mechanisms

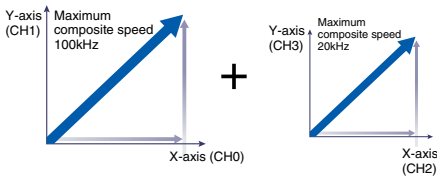

#### Controls 2 units of 2-axis XY table

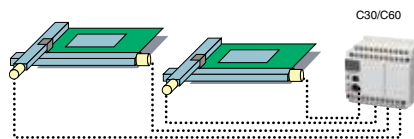

#### The relay output type is also capable of 2-axis linear interpolation

By adding 2 pulse I/O cassettes (AFPX-PLS), linear interpolation is possible at the maximum composite speed of 80kHz. The command used for this unit is F175 (SPSH), the same as that for the transistor output types.

### High-speed counters: 8 built-in sets

8 single-phase or 4 dual-phase sets (X0-X7)

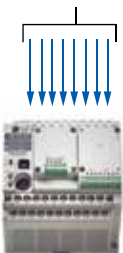

Model type	Input mode	1 channel in use	All channels in use
Transistor output type	Single phase	100kHz	50kHz x 4ch + 10kHz x 4ch
	Dual phase	35kHz	20kHz x 2ch + 5kHz x 2ch
Relay output type	Single phase	10kHz	10kHz x 8ch
	Dual phase	5kHz	5kHz x 4ch

When adding a pulse I/O cassette to the relay output type, 2 high-speed counter sets can be added to every cassette. Please refer to the user manual for counter specification.



# FP-X0 – The multi-functional, economical PLC

## Features

- 2-axis pulse output function  
L14 is 1-axis pulse output, while L30/L40/L60 are 2-axis, and the pulse output function is integrated in the CPU. The 2-axis type can realize linear interpolation (only for L40 and L60).
- Analog input function  
Multi-functional analog input (10 bit, 2-channel), voltage input (0 to 10V), thermistor input and adjustable potentiometer input.
- Line up  
6 kinds of control units L14R, L30R, L40R and L60R: Ry+Tr, AC L40MR, L60MR: Ry+Tr, RS485, AC
- Performance  
High processing speed  
High speed of 80ns/step for 0 to 3000 steps (ST command).  
580ns/step processing speed for 3001 steps or more.



## Specifications

PLC type	L14R	L30R	L40R	L40MR	L60R	L60MR
Number of I/Os	14	30	40	40	60	60
Program capacity	2.5k steps	8k steps				
Operation speed	0.08μs/step (basic instructions)					
Data registers	2500 words					8192 words
Internal relays	1008 points					4096 points
Analog input	No	2 channels, for inputting any of the following items in each channel				
		Potentiometer input Min. resistance value of potentiometer: 5kΩ 10-bit resolution (0 to 1000) Accuracy ± 1.0% F.S.+ accuracy of external resistors				
		Thermistor input For inputting the resistance value of the thermistor (Min. resistance value of external thermistors + external resistance value >2kΩ) 10-bit resolution (0 to 1023) Accuracy ± 1.0% F.S. + accuracy of external thermistors 2kΩ)				
		Voltage input Absolute max. input voltage: 10V 10-bit resolution (0 to 1023) Accuracy ± 2.5% F.S. (F.S. = 10V)				
Clock/calendar function	No					Yes



7 steps to higher efficiency

# FP7 „Seven steps to higher efficiency”

## Features

Compact size with room for expansion functions

- Equipped with a cassette interface.
- Add-on cassettes can be added to the CPU to increase functionality without increasing the footprint of the system.
- Up to 16 different units can be connected to a single CPU.
- High-capacity SD (SDHC) memory cards of up to 32GB are supported.
- High performance with max. 20 $\mu$ s for 60k steps; the processing speed is less affected by frequent Ethernet communication.



Item	Specifications		
Part number	AFP7CPS31	AFP7CPS31E	AFP7CPS41E
Power supply	24V DC or FP power supply unit		
Input	12–24V DC, 24V DC (sink/source)		
Output	Relay: 2–5A, transistor: 0.1–0.5A (varies with different models)		
Number of I/O points	1024		
Expansion	Up to 16 units		
Operation speed	11ns/step (for basic instructions)		
Program memory	Built-in flash ROM (no backup battery required)		
Max. program capacity	120k steps		196k steps
Operation memory	Internal relays	120k steps	
	Timer (T)		
	Counter (C)	Free settings possible	
Ethernet function	–	Built-in	
Constant scan	Available (0–125ms)		
Clock/calendar function	Built-in		

# FP7: Panasonic know-how inside!

Panasonic has a large number of factories worldwide. All our industry PLCs contain the experience and expertise of our machine and production engineers.



# FP7 application examples

## Lighting control system



Use the FP7 together with an Eco-POWER METER such as KW2G and a wireless unit to gather data from exterior lighting systems and monitor energy consumption. Data can be logged and visualized remotely on an office PC with the FP Data Analyzer software.

- Remote control of the FP7 with a PC
- Data logging with SD card
- Easy monitoring of the complete lighting system
- Wireless systems reduce installation costs

## Analog control (high-speed temperature control)

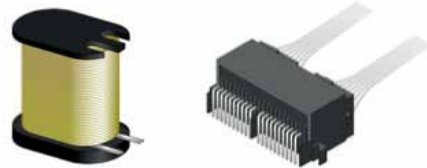
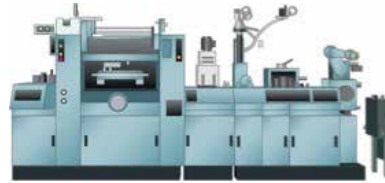

Use an impulse heat controller with high-speed PID control for applications such as thermo-compression bonding, thermal welding, etc.

- Conversion of thermocouple input to achieve high-speed PID control with high precision
- High-speed analog sampling of 25 $\mu$ /s.
- High precision with linearity of  $\pm 0.05\%$  F.S.

## Monitoring energy consumption of buildings

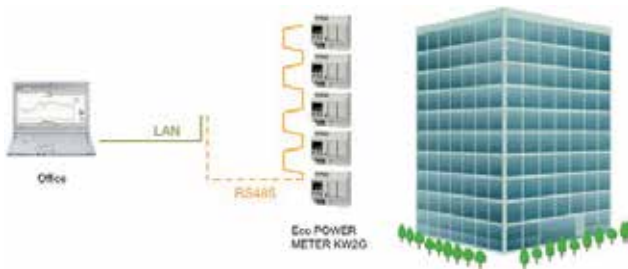

Use the FP7 together with a Eco-POWER METER to monitor the energy consumption of each floor in a building.

- Ability to visualize and monitor the energy consumption (lighting, air conditioning, etc.) of each floor.
- Only one CPU necessary thanks to the FP7's big program capacity and the LAN port available.
- Measurement data can be stored on SD card.

## Visualization of energy consumption in manufacturing plants



Use the FP7 and Web Datalogger unit to monitor the energy consumption of each part in a plant.

- Electricity data can be collected at various locations.
- Multiple Web Datalogger units can be accessed simultaneously
- CPU communication with 16 locations simultaneously via LAN
- Create flexible Excel sheets for energy monitoring with the Data Analyzer
- Measurement data can be stored on SD card

## FP7 units



### Communication cassettes

Specifications	Part number
RS232C, 1 channel (insulated)	AFP7CCM1
RS232C, 2 channels (insulated)	AFP7CCM2
RS422 or RS485, 1 channel (insulated)	AFP7CCS1
RS422 or RS485, 2 channels (insulated)	AFP7CCS2
RS232C, 1 channel (insulated) and RS485, 1 channel (insulated)	AFP7CCS1M1
Ethernet 100Base-TX/10Base-T	AFP7CCET1

### Application cassettes

Specifications	Part number
2-channel analog input 0–10V/0–5V/0–20mA, resolution 12 bit, conversion speed 1ms/channel (non-insulated)	AFP7FCAD2
2-channel analog input 0–5V/0–10V/0–20mA, resolution 12 bit, conversion speed 1ms/channel (non-insulated); 1-channel analog output 0–10V/0–20mA	AFP7FCAD21
2-channel thermocouple input, K/J type, resolution 0.1°C, conversion speed 100ms/2 channels (insulated)	AFP7FCTC2



### Positioning units

Specifications				Part no.
Output type	Number of axes controlled	Max. operation speed	Functions	
Transistor	2 (independent)	1–500kpps	Electronic gear and cam function, linear interpolation, circular interpolation	AFP7PP02T
	4 (independent)			AFP7PP04T
Line driver	2 (independent)	1–4Mpps		AFP7PP02L
	4 (independent)			AFP7PP04L

### Pulse output units

Specifications				Part no.
Output type	Number of axes controlled	Max. operation speed	Functions	
Transistor	2 (independent)	1–500kpps	Linear acceleration, S-shaped acceleration and deceleration control	AFP7PG02T
	4 (independent)			AFP7PG04T
Line driver	2 (independent)	1–4Mpps		AFP7PG02L
	4 (independent)			AFP7PG04L





### Input, output and mixed I/O units

Type	No. of points	Connection method	Specifications	Part number
DC input	16	Terminal block	12 to 24V DC, configurable input time constant	AFP7X16DW
	32	MIL connector	24V DC, configurable input time constant	AFP7X32D2
	64	MIL connector	24V DC, configurable input time constant	AFP7X64D2
Relay output	16	Terminal block	Relay, 2A/point, 5A/common, 16 points/common	AFP7Y16R
Transistor output, sink (NPN)	16	Terminal block	Load current 1.0 A, 5A/common, 16 points/common	AFP7Y16T
	32	MIL connector	Load current 0.3A, 3.2 A/common, 32 points/common	AFP7Y32T
	64	MIL connector	Load current 0.3A/0.1A, 3.2A/common, 32 points/common	AFP7Y64T
Transistor output, source (PNP)	16	Terminal block	Load current 1.0A, 5A/common, 16 points/common	AFP7Y16P
	32	MIL connector	Load current 0.3 A, 3.2 A/common, 32 points/common	AFP7Y32P
	64	MIL connector	Load current 0.3A/0.1A, 3.2A/common, 32 points/common	AFP7Y64P
DC input, transistor output, sink (NPN)	Input: 32 Output: 32	MIL connector	Input: 24V DC, 32 points/common Output: load current 0.3A/0.1A, 3.2A/common, 32 points/common	AFP7XY64D2T
DC input, transistor output, source (PNP)	Input: 32 Output: 32	MIL connector	Input: 24V DC, 32 points/common Output: load current 0.3A/0.1A, 3.2A/common, 32 points/common	AFP7XY64D2P



### Analog input and output units

Number of channels	Specifications	Part number
4 channels	Voltage/current, conversion rate 25 $\mu$ s/channel, resolution max. 16 bit, accuracy max. $\pm$ 0.05% F.S. (at 25°C)	AFP7AD4H
4 channels	Voltage/current, conversion rate 25 $\mu$ s/channel, resolution max. 16 bit, accuracy max. $\pm$ 0.05% F.S. (at 25°C)	AFP7DA4H



### High-speed counter unit

Number of channels	Specifications	Part number
2 channels	16MHz (for two-phase factor 4 input mode)	AFP7HSC2T
4 channels	4MHz (for incremental/decremental input mode)	AFP7HSC4T



### Serial communication unit

Number of channels	Part number
For 2 serial communication cassettes, max. 8 units can be installed per CPU	AFP7NSC

## 24V DC power supply units

### Features

- High power density with minimal losses
- Up to 91.5% efficiency (FP-PS24-060E)
- Wide ambient temperature range from -10°C to +70°C, without performance loss
- Safety approvals (IEC 60950, UL60950, CSA22.2-60950, EN 60950)
- Protection class II, without grounding
- Easy mounting and wiring
- Extremely compact with optimal air cooling



FP-PS24-0120E (24V DC/5A)    FP-PS24-024E (24V DC/1A)    FP-PS24-060E (24V DC/2.5A)

### Specifications

Item	FP-PS24-024E	FP-PS24-060E	FP-PS24-0120E	
Primary side	Rated input voltage	100–240V AC/DC, 50–60Hz		
	Power supply voltage	85–264V AC, 47–63Hz (DC 100–375V), wide range power supply, switching ranges unnecessary		
	Input current	Fulfills the requirements of EN 61000-3-2 (limits for harmonic current emissions)		
	Fuse	Internal in power supply T4AH/250V, not accessible		
Secondary side	Output voltage	24V DC nominal		
	Accuracy, output voltage	±1% over the complete load and input voltage range		
	Adjustable range with potentiometer	23V–29V		
	Output capacity (min.)	0A		
	Current limiting (typ.)	2A continuous, 2A dynamic	2.7A continuous, 5A dynamic	5.3A continuous, 9.5A dynamic
Ripple voltage (< 20MHz)	= 40mVSS measured at 20MHz, 50 Ohms terminated			
Safety	Output	Safety extra low voltage (SELV) EN 60950		
	Class of protection	Class II (with additional constructive measures)		
	Degree of protection	IP20		
	Leakage current	< 0,25mA (47-63Hz and max. 264V AC)		

## FP Web-Server & FP Web Expansion Unit: Safe, easy and cost-effective M2M communication

### Worldwide communication

The FP Web-Server unit connects all FP series controllers to the Ethernet. No changes to the PLC programs are necessary. Simply assign an IP address to the FP Web-Server and connect it to the PLC via the serial RS232C interface. A standard browser, e.g. MS Internet Explorer, can be used for access at the PC. Configuration of the unit is easily done with the FP Web Configurator Tool, which has to be ordered once separately.



## Main features:

### Web-Server:

- PLC data presented as HTML pages
- Access via standard Internet browser
- HTML entry field for PLC data change
- Optional password protection
- Java applet functions library

### Data logger:

- Logging of PLC data and saving it on an SD memory card or transmitting it via FTP (only possible when FP Web Expansion unit is attached)

### Email:

- PLC can send e-mails, also with PLC data attachments
- E-mail server access via LAN or Internet dial-up
- PLC defined or pre-stored mail text

### RS232C device server:

- Ethernet RS232C conversion (MEWTOCOL)
- Transparent RS232C data tunnelling via Ethernet
- Programming and visualization access via Ethernet

### Modem / Ethernet gateway:

- FP Web-Server can be dialed up via modem for local or network access
- One remote gateway for multiple FP Web-Servers in a local Ethernet network
- Remote password handling

### Modbus-TCP communication:

- Modbus-TCP server or client for a PLC
- Modbus-TCP server for multiple PLCs
- Modbus-TCP server gateway for Modbus-RTU slave unit(s)
- Modbus-TCP client gateway for any Modbus-RTU master
- Modbus-TCP master or slave interface for a PLC

### Other functions:

- XML file delivery for PLC data exchange
- Network time server functions

### Advantages:

- Uses existing Intranet, saves wiring
- Uses standard browser, saves SCADA software
- Remote control
- Remote monitoring
- Remote programming
- Alarm information via E-mail
- Interface / protocol converter

### IEC60870 Communicator

With the IEC60870 Communicator add-on license, remote process stations can easily be linked to supervisory control systems or telecontrol main stations. Both modem connection (IEC 60870-5-101) and Ethernet or TCP/IP (IEC 60870-5-104) are supported in one module.

The IEC 60870-5 is an international standard for telecontrol protocols. It provides high transmission reliability and allows to link devices of various manufacturers. Highly precise timestamps compliant to IEC standard can also be transmitted.

## Specifications

Item	FP Web-Server	FP Web Expansion
Part number	FPWEB2	FPWEBEXP
Current consumption	65mA	Additional 20mA on FP Web-Server
Operating voltage	24V DC (10.8 – 26V DC)	Internally powered by FP-WEB2
Communication port	RS232C to connect to the PLC, RS232C to connect to a modem, 100Base-TX/10Base-T Ethernet	USB host port (supports GT series and FP-X PLCs), RS485
Storage space	Built-in Flash ROM	SD/SDHC card slot
Data logging	Via FP Web Expansion	Logging on SD/SDHC Card
Digital output	Via FP Web Expansion	High-speed photo coupler
Communication protocols	MEWTOCOL, DNS, HTTP, HTTPS, SMTP, FTP, TELNET, TCP/IP, UDP/IP, PPP, SNTP, Modbus RTU, Modbus-TCP, SNMPv1, IEC 60870-5-101, IEC 60870-5-104	
Security	Password protection, IP lock	
Ambient temperature	0°C to +55°C	
Storage temperature	-20°C to +70°C	
Dimensions (W x H x D)	25 x 90 x 60 (mm)	
Weight	0.11kg	0.07kg
Software (Part number)	FP Web Configurator (FPWEBTOOL2D)	IEC 60870 license for FPWEB2 (IEC60870LIS) / FP Web Designer (AFPS36510-E)

## One programming software for all FP series PLCs

Control FPWIN Pro is the Panasonic programming software developed according to the international standard IEC 61131-3 (for Windows® 2000/XP/Vista/7/8).

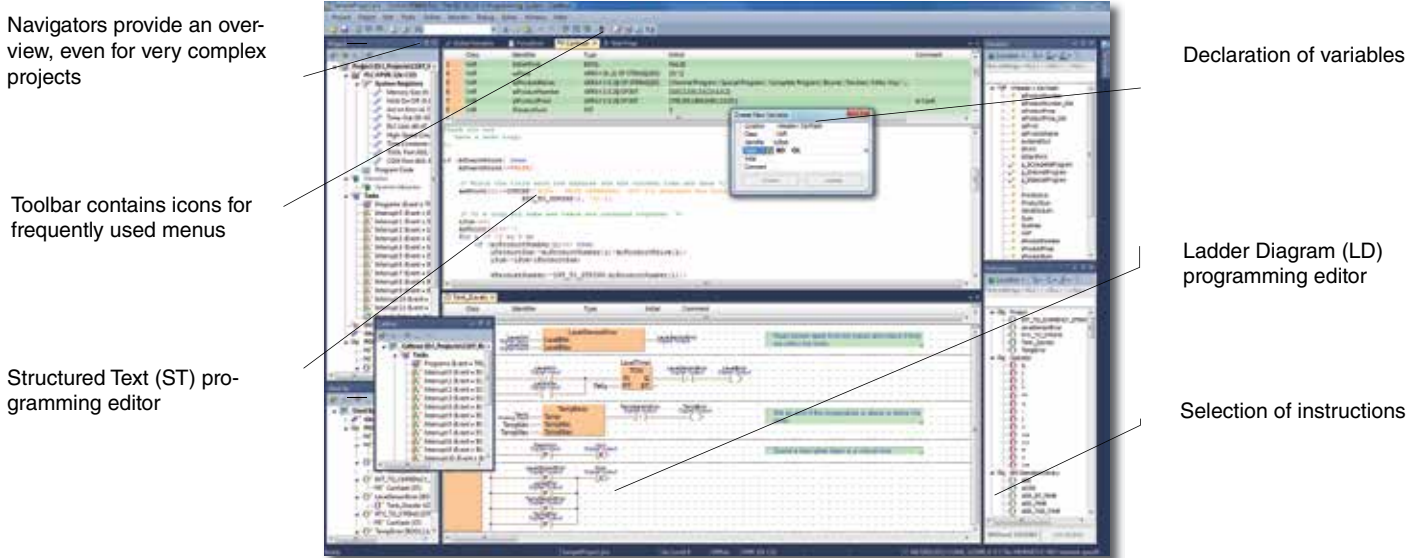

## Control FPWIN Pro highlights

- 5 programming languages: IL (Instruction List), LD (Ladder Diagram), FBD (Function Block Diagram), SFC (Sequential Function Chart), ST (Structured Text)
- 8 languages are fully supported: English, German, French, Italian, Spanish, Japanese, Korean, and Chinese
- Well-structured through program organization units, task and project management
- Remote programming, service and diagnostics via modem or Ethernet
- Extensive comments and online documentation created hand in hand with the program
- Minimum program size through optimized compiler
- Powerful debugging and monitoring tools provide information on the current status of the PLC
- Comprehensive printed documentation and support for function blocks and libraries help to get your hardware running in record time while maintaining rigorous quality standards
- Reuse of functions and function blocks saves time

Product	Part number
Control FPWIN Pro 7 programming software, version 7 (for all FP series PLCs)	FPWINPRO7
Control FPWIN Pro upgrade to version 7 (upgrades all former versions of Control FPWIN Pro to version 7)	FPWINPRO7-UP

Ready-made Libraries	Part number:
Ethernet Library	NCL-ET1-LIB
Process and Temperature Control Library	NCL-PTC-LIB
Inverter Serial Communication Library	NCL-ISC-LIB
GSM Communication Library	NCL-CG-LIB
Modem Communication Library	NCL-CMEU-LIB
Motion Control Library	NCL-MC-LIB
Modbus Library, master and slave functionality	NCL-MODBUS-LIB
Control configurator MS open version	NCLCCMSLIB
Many other ready-made libraries including Master/Slave of PROFIBUS/ DeviceNet/CANopen function blocks can be downloaded from <a href="http://www.panasonic-electric-works.com">www.panasonic-electric-works.com</a> (download area)	

## Website editor for FPWEB2

FP Web Designer is an easy-to-use editing tool for creating Websites for visualizing all process graphics and displaying process data collected by FP Web-Server. No programming knowledge for HTML, PHP, JavaScript or Java is required! Extensive graphic libraries help users with their design work.

## Features of FP Web Designer

- WYSIWYG (What you see is what you get) editor for graphic design of applications
- The designed pages can be called up by a web browser on any PC connected to LAN or WAN
- All process values are shown automatically on the screen. Each diagram can display up to 5 trend curves for measured values stored in PLCs. A simple mouse click updates the page
- The measured values together with trend curves can be stored as CSV files
- Alarm information can be visualized in web browser and saved. Updating alarm information runs in the background so that the web pages always display the current status in the browser.
- The Web pages in the browser can be password-protected to prevent unauthorized access and changes
- Process values can be imported in CSV format from PLC programs written with Control FPCWIN Pro
- Extensive and expandable macro libraries available
- Online help in English and German

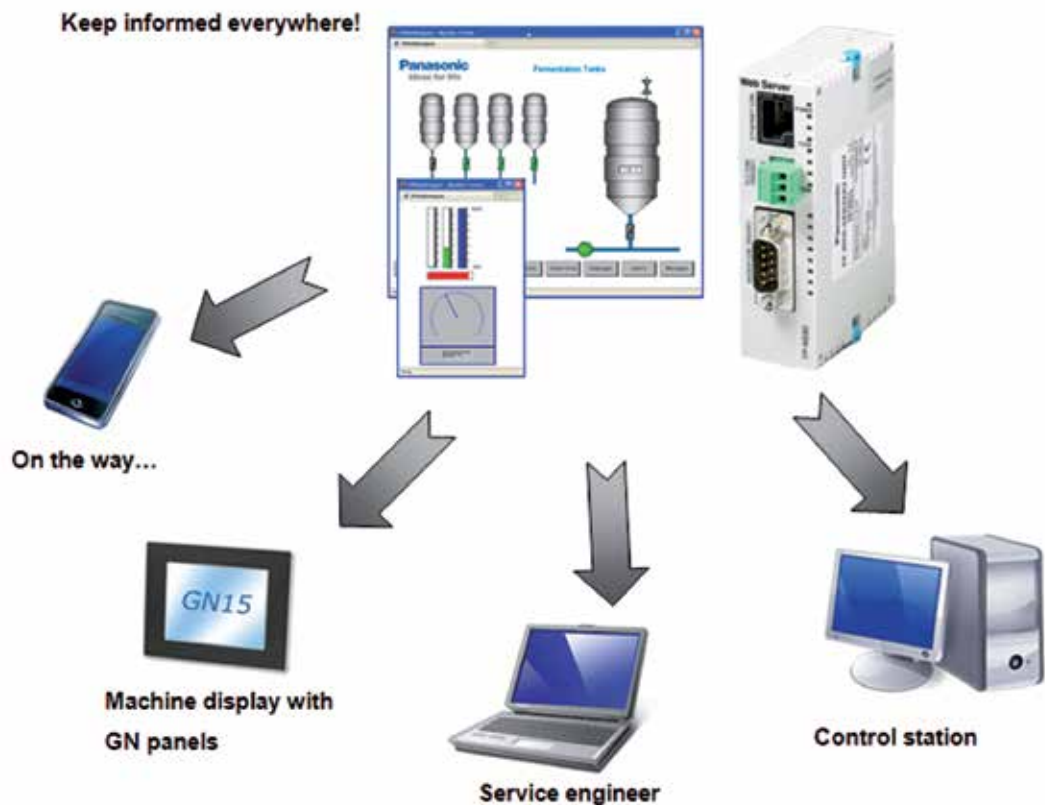

With the help of integrated macro functions in FP Web Designer, alarm reports and diagrams of measured values can be easily embedded into the designed graphic application.

Part number	Description	Comments
AFPS36510-E	FP Web Designer, economy edition	Limited to 250 process points, 15 views, 1 offline trend + 1 alarm
AFPS36510-B	FP Web Designer, basic edition	FP Web Designer, limited to 500 process points, 30 views, 3 offline trends + 1 alarm
AFPS36510-X	FP Web Designer, extended edition	No limitation

# Fieldbus Master Units

The expansion Fieldbus Master Units (FMU) for FP $\Sigma$  (Sigma) and FP7 PLCs are available for three bus systems: PROFIBUS, DeviceNet and CANopen. Others are planned for the future.

## Advantages of the hardware:

- Up to 2 FMUs can be connected to FP $\Sigma$  (Sigma) CPU. The number of FP2 FMUs is restricted by the size of the FP backplane and the power supply capacity.
- One PLC hardware platform for several bus systems
- Gateway function between fieldbus types simply by connecting the corresponding expansion units to the same CPU

For each network type, free ready-made function libraries are available for the programming software Control FFWIN Pro.

They also include a comprehensive online help and programming examples.



FP $\Sigma$  FMU PROFIBUS:  
FPG-DPV1-M

FP $\Sigma$  FMU DeviceNet:  
FPG-DEV-M

FP $\Sigma$  FMU CANopen:  
FPG-CAN-M

FP2 FMU PROFIBUS:  
FP2-DPV1-M

FP2 FMU DeviceNet:  
FP2-DEV-M

FP2 FMU CANopen:  
FP2-CAN-M

Control Configurator FM is an add-on software for Control FFWIN Pro and is used to configure and diagnose the FMUs.

## Advantages of the software:

### One configuration software for various fieldbus systems

- One-time cost, several network types
- Only one installation necessary

### Integrated in the PLC programming software Control FFWIN Pro

- No additional software required on the PC
- Bus-relevant global variables are automatically generated for the PLC program, preventing errors
- Fully integrated in the FFWIN Pro project file, no separate files on PC

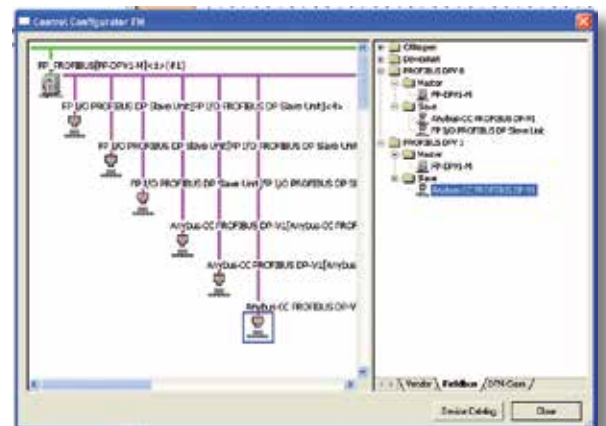

Part number: **AFPS35510**

## FMU (Fieldbus Master Unit) specifications

Item	PROFIBUS	DeviceNet	CANopen
Bus type	RS485	CAN / ISO 11898	
Number of slaves	125	63	126
Number of process data	3584 bytes for inputs and 3584 bytes for outputs		
Bus length	100m (12Mbit/s), 200m (1.5Mbit/s), 400m (500kbit/s), 1km (187.5kbit/s)	100m (500kbit/s), 250m (250kbit/s), 500m (100kbit/s)	40m (1Mbit/s), 500m (100kbit/s)
Connection types	DP-V0: process data is accessed from the PROFIBUS network as cyclical I/O data	<ul style="list-style-type: none"> <li>• Cyclic connections</li> <li>• COS (Change of State)</li> <li>• Bit strobe connections</li> <li>• Polled connections</li> <li>• Explicit connections</li> </ul>	PDO (Process Data Object) exchange via: <ul style="list-style-type: none"> <li>• Cyclic synchronous</li> <li>• Acyclic synchronous</li> <li>• COS (Change of State)</li> <li>• Timer-driven connections</li> </ul>
Internal current consumption	FPG-DPV1-M: 135mA, FP2-DPV1-M: 450mA	FPG-DEV-M: 45mA, FP2-DEV-M: 150mA	FPG-CAN-M: 135mA, FP2-CAN-M: 450mA
Connector type	DB9F (9-pin Sub-D female)	5-pin terminal block	DB9F (9-pin Sub-D male)
Weight	FPG-DPV1-M: 95g, FP2-DPV1-M: 118g	FPG-DEV-M: 95g, FP2-DEV-M: 118g	FPG-CAN-M: 95g, FP2-CAN-M: 118g

Powerful, compact, modular, high performance fieldbus slave units (FSU) are used together with the programmable controllers FPΣ (Sigma), FP2/FP2SH and FP0/FP0R.



## 3 simple steps to set up the network

### 1. Select network

### 2. Download free slave data

PROFIBUS DP	GSD file
DeviceNet	EDS file
CANopen	EDS file
PROFINET IO	GSDML file

Slave units for PROFIBUS DP  
FP2-DPV1-S  
FPG-DPV1-S

Slave unit for PROFIBUS DP (FP0/FP0R expansion unit also compatible with FP-X)  
FP0-DPS2

Slave units for DeviceNet  
FP2-DEV-S  
FPG-DEV-S

Slave units for CANopen  
FP2-CAN-S  
FPG-CAN-S

Slave units for PROFINET IO  
FP2-PRT-S  
FPG-PRT-S

### 3. Download free, ready-made library PEW\_FNS.sul

All the slave data files and ready-made function libraries can be downloaded free of charge from [www.panasonic-electric-works.com](http://www.panasonic-electric-works.com).

The function libraries are used for the programming software Control FPCWIN Pro. They also include a complete online help file and programming examples.

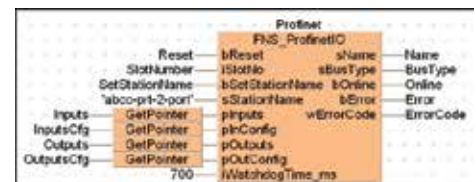

## FSU (Fieldbus Slave Units) specifications

Item	PROFIBUS DP	DeviceNet	CANopen	PROFINET IO
Part no.	FP2-DPV1-S, FPG-DPV1-S FP0-DPS2	FP2-DEV-S, FPG-DEV-S	FP2-CAN-S, FPG-CAN-S	FP2-PRT-S, FPG-PRT-S
Baud rate	<ul style="list-style-type: none"> <li>Automatic baud rate detection</li> <li>9.6kbit/s to 12Mbit/s</li> </ul>	<ul style="list-style-type: none"> <li>Automatic baud rate detection</li> <li>125kbit/s to 500kbit/s</li> </ul>	<ul style="list-style-type: none"> <li>Automatic baud rate detection</li> <li>10kbit/s to 1Mbit/s</li> </ul>	<ul style="list-style-type: none"> <li>100Mbit/s, full duplex (fixed)</li> </ul>
Isolation	Galvanically isolated bus electronics	Galvanically isolated bus electronics	Galvanically isolated bus electronics	Galvanically isolated bus electronics
Connection types	DP-V0: process data is accessed from the PROFIBUS network as cyclical I/O data	<ul style="list-style-type: none"> <li>Cyclic connections</li> <li>COS (Change of State)</li> <li>Bit strobe connections</li> <li>Polled connections</li> <li>Explicit connections</li> </ul>	PDO (Process Data Object) Exchange via: <ul style="list-style-type: none"> <li>Cyclic synchronous</li> <li>Acyclic synchronous</li> <li>COS (Change of state)</li> <li>Timer-driven connections</li> </ul>	PROFINET IO conformance class B Cyclic Data Exchange via PROFINET IO Real Time (RT) communication, 2ms cycle time
Maximum inputs / outputs	<ul style="list-style-type: none"> <li>76 words altogether for inputs and outputs (in units of 1, 2 or 4 words)</li> <li>FP0-DPS2: 6 words/6 words</li> </ul>	E. g. for cyclic connections: 128 words in each direction	Data 128 words (for TPDOs and RPDOs)	128 words of real time IO data, in each direction
Additional features	Diagnostic support	<ul style="list-style-type: none"> <li>UCMM capable</li> <li>CIP parameter object</li> <li>Diagnostic support</li> </ul>	Diagnostic support	Diagnostic support
Interface	DB9F (9-pin Sub-D female)	5-pin terminal block	DB9F (9-pin Sub-D male)	Integrated 2-port switch: 2 x RJ45 socket
Weight	FP2-DPV1-S: 119g FPG-DPV1-S: 92g FP0-DPS2: 80g	FP2-DEV-S: 120g FPG-DEV-S: 93g	FP2-CAN-S: 120g FPG-CAN-S: 93g	FP2-PRT-S: 119g FPG-PRT-S: 92g
Dimensions WxHxD	FP2-DPV1-S: 27.7x100x93mm FPG-DPV1-S: 30x90x60mm FP0-DPS2: 25x90x60mm	FP2-DEV-S: 27.7x100x93mm FPG-DEV-S: 30x90x60mm	FP2-CAN-S: 27.7x100x93mm FPG-CAN-S: 30x90x60mm	FP2-PRT-S: 27.7x100x93mm FPG-PRT-S: 30x90x60mm

## Special features of the FP Modem-56k unit for industrial telecontrol:

- Very small size
- Operating voltage 24V DC
- Attachable to a 35mm DIN rail
- Maximum line speed up to 56kbit/s
- Leased line mode (peer-to-peer) up to 20km with 33.6kbit/s
- Multidrop leased line mode according to V.23 at 1200bit/s
- DCD output for connection to the digital input of a PLC
- PSTN text message send + receive (if supported by the PSTN)
- CLIP decoder for calling line identification and callback
- Serial communication interfaces RS232C and RS485 are built-in



Combining the FP Modem-56k with the FP Web-Server expands the horizon of telecontrol even more, e.g. internet access, send e-mails, dial up a FP Web-Server for local or network access, etc. User libraries make the integration of communication functions into PLC programs easy.

## Typical applications for FP Modem-56k:

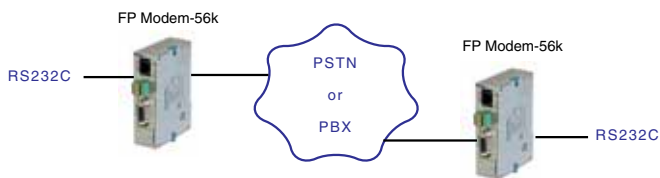

1. Dial-up mode

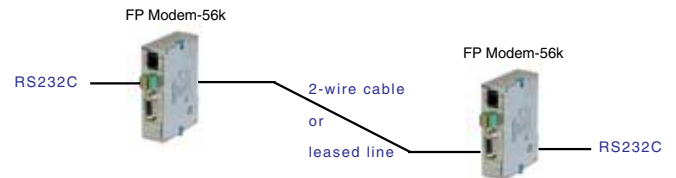

2. Leased-line mode

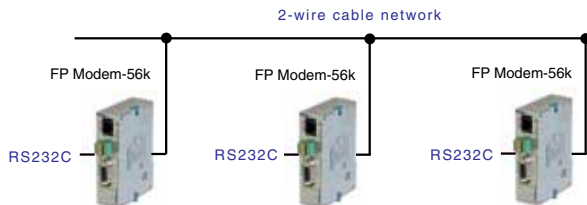

3. Multipoint mode

Specifications	
Part number	FP-MODEM-56k
Operating voltage	24V DC (10.8 to 26.6V DC)
Current consumption	Approx. 50mA
LEDs	Power, DCD (Carrier detect), RI (Ring), RTS (request to send), RxD, TxD (Data)
Ambient temperature	0 to +55°C
Connection to PLC, PC or FP Web-Server	RS232C (Sub-D 9-pin female), RS485 (Phoenix screw terminal)
Connection to the telephone network	RJ12 jack and RJ12 - RJ12 cable, national adapter is not enclosed
Carrier detect connection	Phoenix screw terminal
Error correction	V.42, LAPM, MNP
Data compression	V.42bis, V.44
Dialing method	Pulse dialing, tone dialing (DTMF)
Control / Operation	Extended AT command set, Hayes compatible (V.250)
Operation modes	Automatic selection, V.21, V.22, V.23, V.22bis, V.32, V.32bis, V.34, V.90, V.92
DTE speed (RS232C baud rate)	300, 600, 1200, 2400, 4800, 9600, 19200, 38,400, 57,600, 115,200bit/s
Line transmission speed	Up to 56kbit/s with V.90
Compliance with standards	CE marking (ES-203021 approval), US approval (US: C04MM05B077FP)
Dimensions (W x H x D)	25 x 90 x 64mm



## Standardized connection to SCADA/HMI software

The Panasonic OPC server allows high-performance data transfer between applications supporting the universally accepted OPC DA Standard (v1-v3) and Panasonic FP series PLCs.

The screenshot shows the 'Temperature Control - FP OPC Server' application. It features a 'Navigator' pane on the left showing a hierarchical tree of 'Const', 'Temperature', and 'Tag' elements. A central table lists tag details such as Name, Address, Data Type, Time Stamp, Access Right, and Description. A 'System Log' pane at the bottom left shows event messages with columns for Date/Time, Type, Source, and Event. A 'Server Status' pane at the bottom right displays metrics like Server Time, Up Time, Connected Clients, Number of Tags, and Number of Elements.

Annotations with arrows point to these specific areas:

- Navigator pane** shows the hierarchical structure of channel, device and tag group elements.
- Tag pane** shows the tag elements in a list structure. Multiple rows can be selected and changes applied to all selected elements.
- System log pane** displays information, warnings and error event messages.
- Server status pane** shows actual status information about the server application, e.g. server time, up time, connected clients and number of tags.

### Features of the FP OPC server

- Modern and intuitive user interface allows you to configure the server. While you are creating the application, sophisticated user assistance and help is omnipresent.
- The server complies to the following OPC DA client/server technologies:  
 OPC DA 1.0a  
 OPC DA 2.05a  
 OPC DA 3.0
- The PLCs can be accessed via serial, modem and Ethernet communication lines.
- State-of-the-art import / export mechanism allows you to save, exchange or edit data in XML format. Data can also be exchanged with other Panasonic software products, e. g. FPWIN Pro, using a CSV file.
- An icon or tool tip notifies the user about possible errors in configuration.
- The FP OPC Server allows you to clearly structure your application, e.g. by grouping elements in meaningful hierarchies.
- Tolerant of interruptions: if a connected device stops responding, e. g. because the line is interrupted, the communication is carried on for the other connected devices.

#### Part number

FP OPC Server software with one license	AFPS03510D
---	------------

## Read and display PLC data

The FP Data Analyzer is a software tool for acquisition, logic analysis and representation of recorded data on multiple channels connected to any Panasonic PLC. The software is a stand-alone tool. You need not install any other software to run the FP Data Analyzer.

The FP Data Analyzer can be connected to any Panasonic PLC by utilizing the integrated MEWNET Manager, for instance via any COM port. Recording and analyzing remote PLCs, sensors, actuators, etc. via LAN or modem is just a matter of seconds. In addition, not only PLCs can be analyzed with the FP Data Analyzer! Via the integrated OLE interface, the P500 image processing software can also send samples to the analyzer.

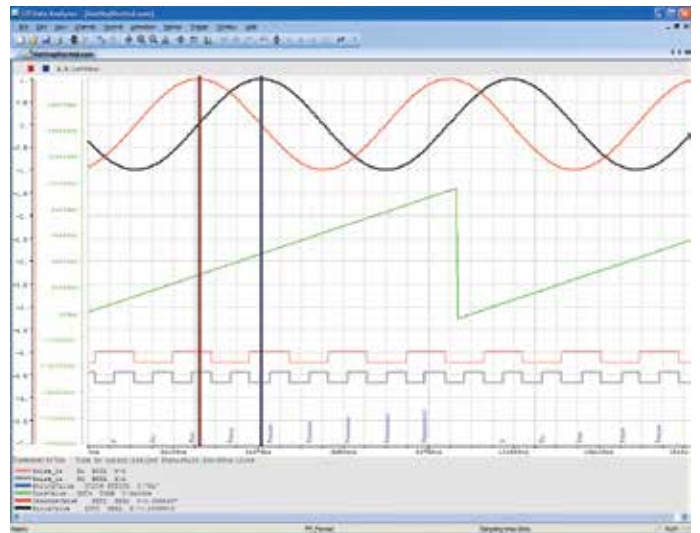

### Features of the FP Data Analyzer

- LAN and modem connection for remote control via LAN, Internet or telephone line
- Concurrent data acquisition from several independent PLCs
- Acquisition of all internal and external PLC registers, relays, counters, timers, arrays and even DUTs
- Connection to P500 image processing software
- Data types can be recorded and displayed as: BOOL, INT, DINT, WORD, DWORD, REAL, STRING, ARRAY
- Adding new channels while recording
- Variable list compatible to Control FPCWIN Pro GVL export
- Trigger functions with pre-trigger, post-trigger
- User-defined sampling rate from a few milliseconds to hours or even days
- Each channel can be displayed in any color and trace width
- Display signals graphically as single channels, in XY-mode or in tables
- Time measuring function with up to 4 markers plus 2 trigger markers
- Jump to time
- Jump to an analog value
- Virtually unlimited number of samples

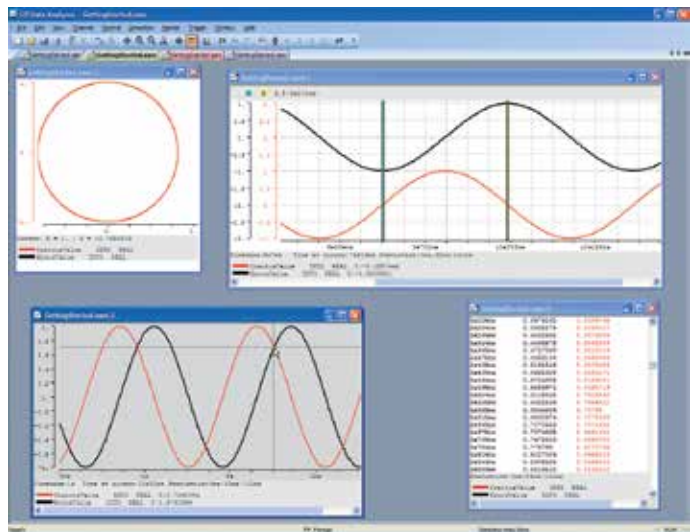

#### Part number

FP Data Analyzer software

AFPS04510D

# The connection in ActiveX® technology

## Connecting your application to Panasonic PLCs

### Main advantages:

- Control FP Connect provides One ActiveX® control for Microsoft Foundation Classes (MFC), Microsoft.NET (Visual Basic and C#), Office applications and COM applications.
- No knowledge of Panasonic PLC communication protocol (MEWTOCOL) is needed for developing applications which communicate with Panasonic FP series PLCs, no matter which programming language is used: VB, C#, C, HTML, JavaScript, Delphi, etc.
- Control FP Connect provides many ready-to-use function sets for easy application development.

#### **Control:**

- AboutBox
- ShowParameter
- PortOpen
- PortClose
- AttachHostHandle
- ChangeTimeout

#### **PLC read:**

- AreaRead
- ReadBits
- ReadINT
- ReadDINT
- ReadWORD
- ReadDWORD
- ReadREAL
- ReadICCard
- MonitorRead

#### **PLC write:**

- AreaWrite
- WriteBits
- WriteINT
- WriteDINT
- WriteWORD
- WriteDWORD
- WriteREAL
- WriteICCard
- WriteSharedMemory

#### **Special commands:**

- TransparentMode
- ReadPLCInformation
- ChangePLCMode
- PLCPassword
- UploadPLCCode
- DownloadPLCCode

## Specifications

- FP Connect available for all Windows operation systems
- Support multiple connections to Panasonic PLCs and HMIs with integrated MEWNET Manager
- Communicate with FP series PLCs using interfaces such as RS232C, RS485, modem, Ethernet
- Read/Write PLC contacts, registers and shares memory
- Up- and downloads of PLC programs and system registers
- Provides many high-level commands like ReadPLCInformation for easy data acquisition
- Display or change status of the PLC (RUN/PROG)
- Provide PLC password function

Part number	
Control FP Connect	AFPS37510

## One tool for GTs and PLCs to transfer project data without having an engineering system

The system information, program and data from Panasonic GT series and FP series can be uploaded with this software tool. The uploaded data can either be downloaded immediately to another GT or PLC of the same type or saved on disk for later usage.

### GT features

- Read panel system information
- Upload project file
- Download project file
- Save panel project as single file
- Download firmware

### PLC features

- Upload program and data
- Download program and data
- Register types and ranges of variables for up/download freely definable by user
- Include Flash & EEPROM data
- Save PLC project as single file

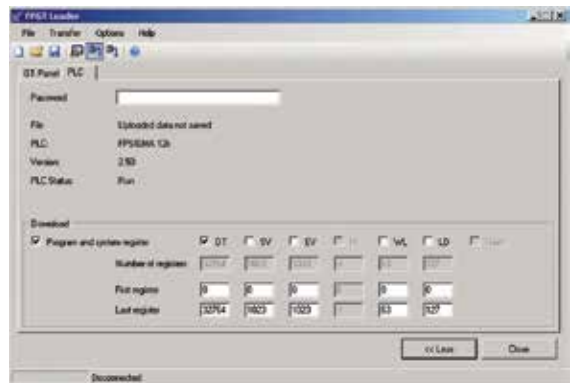
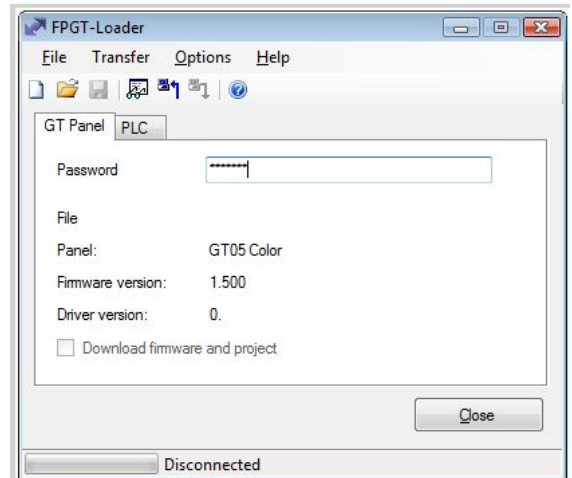

### Part number

FPGT Loader	AFPS77510
-------------	-----------

## PCWAY data monitoring, logging and setting software based on Excel®

PCWAY is a unique add-in software for Microsoft Excel. With PCWAY, it is possible to display PLC data on an Excel sheet. The data display will be updated continuously. Certain events (rising or falling edges of relays or PCWAY events) can be output as a sound.

### Features

- Real-time display of the PLC memory area in the Excel cell
- Changing the PLC memory area directly from the Excel cell
- Saving PLC data to a file and displaying the data saved
- Booting Excel macros automatically  
By combining the macro with PCWAY, it is possible to automatically generate reports or to change the colors of the charts based on the PLC information
- E-mail function  
PCWAY monitors internal relays of the PLC and sends the equipment status information to a PC or a cellular phone via e-mail when the internal relay changes from OFF to ON

### Part number

PCWAY software with USB port dongle	AFW10031
USB port dongle for PCWAY and CommX	AFW1033

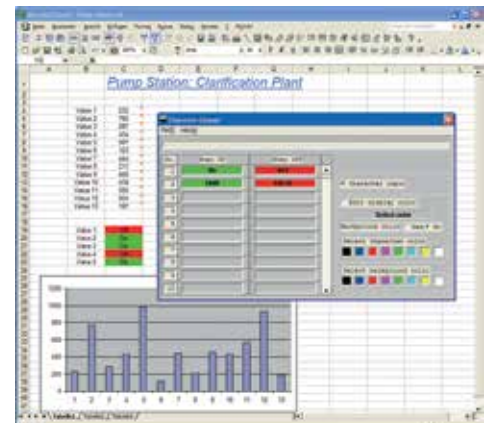

## Signal converter for RS232C/RS485 <-> Ethernet

- Easy to connect  
The connectors are located on the front panel
- Easy to configure  
The IP address can easily be set by using the "Configurator WD" software
- Easy-to-install DIN-rail mountable type

### Exemple de configuration du système

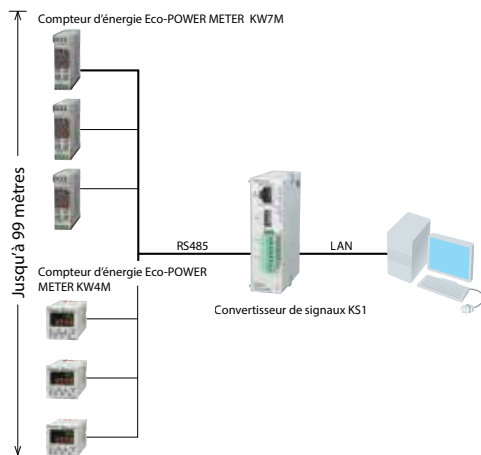

## Communication specifications

RS232C and RS485		
Interface	RS232C (non insulated)	RS485 (insulated)
Conversion COM port	COM1	COM2
Communication style	1:1 communication	1:N communication
No. of connectable stations	1 station	99 stations max.
Communication method	Full duplex	Half duplex
Transmission distance	15m	Max. 1200m
Communication speed	2400, 4800, 9600, 19,200, 38,400, 57,600 and 115,200bit/s	
Number of connectable connections	3	3
COM receive time out	Setting range: 10ms to 60s	
Non-communication time before disconnection	Setting range: 0 to 1800s	
Conversion and transmission format	Data length	8 bits fixed
	Parity	Odd/Even/None
	Stop bit	1 bit/2 bits
	End code	CR, CR+LF, None
Ethernet to serial conversion	Command/response system	

## Performance specifications

Item	AKS1202	
Rated voltage	24V DC	
Operating voltage range	90 to 110%V of rated voltage (21.6 to 26.4V DC)	
Inrush current	max. 12A	
Current consumption	max. 200mA	
Allowed momentary power off time	10ms	
Fuse	Built-in type	
Terminal screw	M2	
Ambient temperature	0 to 55°C	
Storage temperature	-20 to +75°C	
Ambient humidity	30 to 85% RH (at 20°C, non-condensing)	
Breakdown voltage	500VAC 1 minute	RS485 terminals as well as combined power and ground terminals
Insulation resistance	100MW or higher (500V DC using an insulation resistance meter)	
Vibration resistance	10 to 55Hz, 1 cycle/min.: double amplitude of 0.75mm, 1 hour on 3 axes	
Shock resistance	294m/s <sup>2</sup> or more, 5 times on 3 axes	
Dimensions (W x D x H)	25 x 60 x 90mm	
Weight	Approx. 80g	

Ethernet		
Interface	IEEE802.3u, 10BASE-T/100BASE-TX	
Connector shape	RJ45	
Transmission specifications	Transmission speed	10Mbit/s/100Mbit/s
	Transmission method	Base band
	Max. segment length	100m
Communication cable	Category 5 UTP cable	
Protocol	TCP/IP	
Functions	Auto negotiation function, MDI/MDI-X, Auto crossover function	

# Part number list

## FP-e CPUs

Description	Part number
FP-e, 8 IN / 6 OUT (5 NPN, 0.5A; 1 relay, 2 A), RS232C, 24V DC	AFPE224300
FP-e, 8 IN / 6 OUT (5 NPN, 0.5A; 1 relay, 2 A), RS485, 24V DC	AFPE224302
FP-e, 8 IN / 6 OUT (5 NPN, 0.5A; 1 relay, 2 A), RS232C, RTC, 24V DC	AFPE224305
FP-e, 6 IN / 6 OUT (5 NPN, 0.5A; 1 relay, 2 A), plus 2 thermocouple inputs, RS232C, RTC, 24V DC	AFPE214325
FP-e, 6 IN / 6 OUT (5 NPN, 0.5A; 1 relay, 2 A), plus 2 thermocouple inputs, RS485, 24V DC	AFPE214322
FP-e, 6 IN / 6 OUT (5 NPN, 0.5A; 1 relay, 2 A), plus 2 analog inputs (0–20mA), RS232C, RTC	AFPE214325T06

## FP-e accessories

Description	Part number
Backup battery	AFPG804
Rubber gasket	ATC18002
Panel cover (black) 20 pcs	AFPE803
Protective cover	AQM4803
Terminal socket set (4 terminal blocks)	AFPE804

## FP0R CPUs

Description	Part number
FP0R-C10, 16k steps, 6 IN / 4 OUT relay (2A), screw terminal block, RS232, USB, 24V DC	AFP0RC10RS
FP0R-C10, 16k steps, 6 IN / 4 OUT relay (2A), screw terminal block, RS232C, USB, 24V DC	AFP0RC10CRS
FP0R-C10 with COM port: RS485 (19,2/115,2kbit/s), TOOL port: RS232 & Mini USB, 16k steps, 6 IN (PNP + NPN), 4 OUT relay, screw terminal block, 24V DC	AFP0RC10MRS
FP0R-C14, 16k steps, 8 IN / 6 OUT relay (2A), screw terminal block, RS232, USB, 24V DC	AFP0RC14RS
FP0R-C14, 16k steps, 8 IN / 6 OUT relay (2A), screw terminal block, RS232C, USB, 24V DC	AFP0RC14CRS
FP0R-C14 with COM port: RS485 (19,2/115,2kbit/s), TOOL port: RS232 & Mini USB, 16k steps, 8 IN (PNP + NPN), 6 OUT relay, screw terminal block, 24V DC	AFP0RC14MRS
FP0R-C16, 16k steps, 8 IN / 8 OUT (0.2A), MIL connector, RS232, USB, 24V DC	AFP0RC16P (PNP), AFP0RC16T (NPN)
FP0R-C16, 16k steps, 8 IN / 8 OUT (0.2A), MIL connector, RS232C, USB, 24V DC	AFP0RC16CP (PNP), AFP0RC16CT (NPN)
FP0R-C16 with COM port: RS485 (19,2/115,2kbps), TOOL port: RS232 & Mini USB, 16k steps, 8 IN (PNP + NPN) / 8 OUT trans., MIL connector, 24V DC	AFP0RC16MP (PNP), AFP0RC16MT (NPN)
FP0R-C32, 32k steps, 16 IN / 16 OUT (0.2A), MIL connector, RS232, USB, 24V DC	AFP0RC32P (PNP), AFP0RC32T (NPN)
FP0R-C32, 32k steps, 16 IN / 16 OUT (0.2A), MIL connector, RS232C, USB, 24V DC	AFP0RC32CP (PNP), AFP0RC32CT (NPN)
FP0R-C32 with COM port: RS485 (19,2/115,2kbps), TOOL port: RS232 & Mini USB, 32k steps, 16 IN (PNP + NPN) / 16 OUT trans., MIL connector, 24V DC	AFP0RC32MP (PNP), AFP0RC32MT (NPN)
FP0R T32, 32k steps, 16 IN / 16 OUT (0.2A), RTC, MIL connector, RS232C, USB, 24V DC	AFP0RT32CP (PNP), AFP0RT32CT (NPN)
FP0R-T32 with COM port: RS485 (19,2/115,2kbps), TOOL port: RS232 & Mini USB, 32k steps, 16 IN (PNP + NPN) / 16 OUT trans., MIL connector, RTC, buffered RAM, 24V DC	AFP0RT32MP (PNP), AFP0RT32MT (NPN)
FP0R F32, 32k steps, 16 IN / 16 OUT (0.2A), FRAM, RS232C, USB, 24V DC	AFP0RF32CP (PNP), AFP0RF32CT (NPN)
FP0R-F32 with COM port: RS485 (19,2/115,2kbps), TOOL port: RS232 & Mini USB, 32k steps, 16 IN (PNP + NPN) / 16 OUT trans., MIL connector, flash RAM, 24V DC	AFP0RF32MP (PNP), AFP0RF32MT (NPN)

## FPΣ (Sigma) CPUs

Description	Part number
FPG-C24R2, 32k steps, 16 IN / 8 relay OUT, terminal block, 24V DC	FPG-C24R2H
FPG-C28P2, 32k steps, 16 IN / 12 OUT transistor (PNP), MIL connector, 24V DC	FPG-C28P2H
FPG-C32T2, 32k steps, 16 IN / 16 OUT transistor (NPN), MIL connector, 24V DC	FPG-C32T2H
FPG-C24R2TM, 32k steps, 16 IN / 8 relay OUT, plus 2 thermistor input, terminal block, 24V DC	FPGC24R2HTM
FPG-C28P2TM, 32k steps, 16 IN / 12 OUT transistor (PNP), plus 2 thermistor input, MIL connector, 24V DC	FPGC28P2HTM
FPG-C32T2TM, 32k steps, 16 IN / 16 OUT transistor (NPN), plus 2 thermistor input, MIL connector, 24V DC	FPGC32T2HTM

## FP $\Sigma$ (Sigma) serial communication unit and cassettes

Description	Part number
FPG-COM1 cassette, 1x RS232C (5 pin)	FPG-COM1
FPG-COM2 cassette, 2x RS232C (2x 3pin)	FPG-COM2
FPG-COM3 cassette, 1x RS485 (3 pin)	FPG-COM3
FPG-COM4 cassette, 1x RS232C (3 pin) and 1x RS485 (2 pin, 19.2 and 115.2kBaud)	FPG-COM4
FPG-COM4 cassette, 1x RS232C (3 pin) and 1xRS485 (2 pin, 2.4 and 9.6kBaud)	AFPG806T17
FPG-SDU unit, 3x RS485 (5 pin), terminal block, 300bit/s to 115,2kbit/s	AFPG951T34

## FP $\Sigma$ (Sigma) accessories

Description	Part number
FPG-EM1 data memory expansion unit, 256Kwords (512kByte)	FPGEM1
Backup battery	AFPG804

## FP $\Sigma$ (Sigma) digital expansion units (left side)

Description	Part number
FPG-XY64D2P expansion, 32 IN / 32 OUT transistor (PNP), MIL connector, 24V DC	FPG-XY64D2P
FPG-XY64D2T expansion, 32 IN / 32 OUT transistor (NPN), MIL connector, 24V DC	FPG-XY64D2T

## FP $\Sigma$ (Sigma) analog expansion units (left side)

Description	Part number
FP $\Sigma$ (Sigma) analog expansion, 4*16bit IN ( 0–10V; 0–20mA with 50 $\Omega$ resistance) and 4x12bit OUTPUT (0–10V, -10 to +10V; 4–20mA), MIL connector, 24V DC	FPGAD44D50
FP $\Sigma$ (Sigma) analog expansion, 4*16bit IN (0–10V; 0–20mA with 250 $\Omega$ resistance) and 4x12bit OUTPUT (0–10V, -10 to +10V; 4–20mA), MIL connector, 24V DC	FPGAD44D250

## FP $\Sigma$ (Sigma) positioning units

Description	Part number
FPG-PP11, 1-axis positioning unit with transistor outputs	FPGPP11
FPG-PP12, 1-axis positioning unit with line driver outputs	FPGPP12
FPG-PP21, 2-axis positioning unit with transistor outputs	FPGPP21
FPG-PP22, 2-axis positioning unit with line driver outputs	FPGPP22
FPG-PN2AN, 2-axis RTEX positioning unit	FPGPN2AN
FPG-PN4AN, 4-axis RTEX positioning unit	FPGPN4AN
FPG-PN8AN, 8-axis RTEX positioning unit	FPGPN8AN
RTEX configuration software	AFPS66510

## FP0R/FP $\Sigma$ (Sigma)/FP-X digital expansion units (right side)

Description	Part number
FP0R-E8 expansion unit, 8 input, MIL connector, 24V DC	FP0RE8X
FP0R-E8 expansion unit, 4 input / 4 relay output, terminal block, 24V DC	FP0RE8RS
FP0R-E8 expansion unit, 8 relay output, terminal block, 24V DC	FP0RE8YRS
FP0R-E8 expansion unit, 8 transistor output, MIL connector, 24V DC	FP0RE8YP (PNP), FP0RE8YT (NPN)
FP0R-E16 expansion unit, 16 input, MIL connector, 24V DC	FP0RE16X
FP0R-E16 expansion unit, 8 input / 8 relay output, terminal block, 24V DC	FP0RE16RS
FP0R-E16 expansion unit, 8 input / 8 transistor output, MIL connector, 24V DC	FP0RE16P (PNP), FP0RE16T (NPN)
FP0R-E16 expansion unit, 16 transistor output, MIL connector, 24V DC	FP0RE16YP (PNP), FP0RE16YT (NPN)
FP0R-E32 expansion unit, 16 input / 16 transistor output, MIL connector, 24V DC	FP0RE32P (PNP), FP0RE32T (NPN)

# Part number list

## FP0R/FP $\Sigma$ (Sigma)/FP-X analog expansion units (right side)

Description	Part number
FP0 analog I/O unit, input 2 points (0 to 5V, -10 to +10V, 0 to 20mA); output 1 point (-10 to +10V, 0 to 20mA); resolution 12 bits, 24V DC	FP0-A21
FP0 A/D converter unit, analog input 8 points (0-5V, -10 to +10V, -100 to +100V, 0 to 20mA), resolution 12 bits, 24V DC	FP0-A80
FP0 D/A converter unit, analog output 4 points: FP0-A04V: -10 to +10V (12bits) FP0-A04I: 4 to 20mA (12bits)	FP0-A04V FP0-A04I

## FP0R/FP $\Sigma$ (Sigma)/FP-X temperature units (right side)

Description	Part number
FP0 thermocouple unit, resolution: 0.1°C, 4 input channels, -100°C to +1500°C	FP0TC4
FP0 thermocouple unit, resolution: 0.1°C, 8 input channels, -100°C to +1500°C	FP0TC8
FP0 RTD unit, Pt100, Pt1000, Ni1000, 6 input channels (3-wire), -200°C to +500°C, resolution 0.1°C	FP0RTD6

## FP0R/FP $\Sigma$ (Sigma) cables and accessories

Description	Part number
I/O cable with 10pin MIL connector and 10 wires, set of two cables (1x blue, 1x white), 1m	AFP0521D
I/O cable with 10pin MIL connector and 10 wires, set of two cables (1x blue, 1x white), 3m	AFP0523D
I/O cable with 10pin MIL connector and 10 wires, set of two cables (blue), 1m	AFP0521BLUED
I/O cable with 10pin MIL connector and 10 wires, set of two cables (blue), 3m	AFP0523BLUED
I/O cable with 10pin MIL connector and 10 wires, set of two cables (orange), 1m	AFP0521ORANGED
I/O cable with 10pin MIL connector and 10 colored wires, set of two cables, 1m	AFP0521COLD
I/O cable with 10pin MIL connector and 10 colored wires, set of two cables, 2m	AFP0522COLD
I/O cable with 40pin MIL connector and 40 blue wires, 1m	AYT58403BLUED
I/O cable with 40pin MIL connector and 40 blue wires, 3m	AYT58406BLUED
I/O cable with 40pin MIL connector and 40 colored wires based on DIN 47100, 1m	AYT58403COLD
I/O cable with 40pin MIL connector and 40 colored wires based on DIN 47100, 3m	AYT58406COLD
Power supply cable for FPWEB2, FP0R and FP $\Sigma$ (Sigma), 1m	AFPG805J
Power supply cable for FP0/FP0R, FP Modem-56k, 1m	AFP0581J
Mounting plate for FP $\Sigma$ (Sigma) CPUs and expansion units on a panel, 10 pcs per set	AFP0811
Slim type mounting plate for FP0 expansion units, 10 pcs per set	AFP0803
FP $\Sigma$ (Sigma) high capacity battery holder. Battery CR123A is not included.	AFPG807
Backup battery	AFPG804
FP Memory Loader, data clear type	AFP8670
FP Memory Loader, data hold type	AFP8671
MIL connector, attaches to transistor output type (2 sockets per pack)	AFP0807
Pressure connection tool for MIL connection	AXY52000FP

## FP-X CPUs

Description	Part number
FP-X-C14R, 8 IN (24V DC) / 6 OUT (2A relay), terminal block, 230V AC	AFPXC14R
FP-X-C14RD, 8 IN (24V DC) / 6 OUT (2A relay), terminal block, 24V DC	AFPXC14RD
FP-X-C14, 8 IN (24V DC) / 6 OUT (transistor, 0.5A), terminal block, 230V AC	AFPXC14P (PNP), AFPXC14T (NPN)
FP-X-C14, 8 IN (24V DC) / 6 OUT (transistor, 0.5A), terminal block, 24V DC	AFPXC14PD (PNP), AFPXC14TD (NPN)
FP-X-C30R, 16 IN (24V DC) / 14 OUT (2A relay), terminal block, 230V AC	AFPXC30R
FP-X-C30R, 16 IN (24V DC) / 14 OUT (2A relay), terminal block, 24V DC	AFPXC30RD
FP-X-C30, 16 IN (24V DC) / 14 OUT (transistor, 0.5A), terminal block, 230V AC	AFPXC30P (PNP), AFPXC30T(NPN)
FP-X-C30, 16 IN (24V DC) / 14 OUT (transistor, 0.5A), terminal block, 24V DC	AFPXC30PDJ (PNP), AFPXC30TDJ (NPN)
FP-X-C38, 32k steps, 24 IN (24V DC) / 14 OUT (transistor NPN, 0.5A), 4 analog inputs (0-10V or 0-20mA, 12 bit) and 2 analog outputs (0-10V or 0-20mA, 12 bit), screw terminal, 230V AC	AFPXC-C38AT



## FP-X CPUs

Description	Part number
FP-X-C60R, 32 IN (24V DC) / 28 OUT (2A relay), terminal block, 230VAC	AFPXC60R
FP-X-C60R, 32 IN (24V DC) / 28 OUT (2A relay), terminal block, 24V DC	AFPXC60RD
FP-X-C60, 32 IN (24V DC) / 28 OUT (transistor, 0.5A), terminal block, 230V AC	AFPXC60P (PNP), AFPXC60T (NPN)
FP-X-C60, 32 IN (24V DC) / 28 OUT (transistor, 0.5A), terminal block, 24V DC	AFPXC60PD (PNP), AFPXC60TD (NPN)

## FP-X expansion units

Description	Part number
FP-X-E16R expansion unit, 8 IN (24V DC) / 8 OUT (2A relay), terminal block	AFPXE16R
FP-X-E16 expansion unit, 8 IN (24V DC) / 8 OUT (transistor, 0.5A), terminal block	AFPXE16P (PNP), AFPXE16T (NPN)
FP-X-E16X expansion unit, 16 IN (24V DC), terminal block	AFPXE16X
FP-X-E14YR expansion unit, 14 OUT (2A relay), terminal block	AFPXE14YR
FP-X-E30R expansion unit, 16 IN (24V DC) / 14 OUT(2A relay), terminal block, 230V AC	AFPXE30R
FP-X-E30RD expansion unit, 16 IN (24V DC) / 14 OUT( 2A relay), terminal block, 24V DC	AFPXE30RD
FP-X-E30 expansion unit, 16 IN (24V DC) / 14 OUT (transistor, 0.5A), terminal block, 230V AC	AFPXE30P (PNP), AFPXE30T (NPN)
FP-X-E30 expansion unit, 16 IN (24V DC /14 OUT (transistor, 0.5A), terminal block, 24V DC	AFPXE30PD (PNP), AFPXE30TD (NPN)
Adapter for connecting FP0 expansion units, 24V DC	AFPXEFP0

## FP-X add-on cassettes

Description	Part number
FP-X I/O cassette, 4 IN (24V DC) / 4 OUT (NPN, 0.3A), terminal block	AFPX-IN4T3
FP-X input cassette, 8 IN (24V DC), terminal block	AFPXIN8
FP-X output cassette, 6 OUT (PNP, 0.5A), terminal block	AFPXTR6P (PNP)
FP-X output cassette, 8 OUT (NPN, 0.3A), terminal block	AFPXTR8 (NPN)
FP-X pulse I/O cassette, HSC input (single-phase 2 ch., each 80kHz or two-phase 1ch., 30 kHz, pulse output: one axis 100kHz/ch. Cannot be used with a transistor output control unit.	AFPXPLS
FP-X analog input cassette, 2 inputs (0 to10V or 0 to 20mA, 12-bit, 2ms/2ch.)	AFPXAD2
FP-X analog output cassette, 2 outputs (0 to10V or 0 to 20mA, 12-bit, 2ms/2ch.)	AFPX-DA2
FP-X analog I/O cassette, 2 ch. inputs (0 to 10V or 0 to 20mA, 12-bit, 2ms/2ch.), 1 ch. output (0–10V or 0–20mA, 12bit, 1ms/ch) (insulated)	AFPX-A21
FP-X thermocouple input cassette, 2-point thermocouple input, K/J type, -50°C to +500°C, resolution 0.2°C, 200 ms/2 ch. (insulated)	AFPX-TC2
FP-X RTD cassette, 2-point RTD input, PT100, -200°C to +850°C, resolution 0.1°C	AFPX-RTD2
FP-X master memory cassette with a clock/calendar function	AFPXMRTC
FP-X-COM1 communication cassette, 1ch. RS232C (5 pin)	AFPXCOM1
FP-X-COM2 communication cassette, 2ch. RS232C (2 x 3 pin)	AFPXCOM2
FP-X-COM3 communication cassette, 1ch. RS485 (3 pin)	AFPXCOM3
FP-X-COM4 communication cassette, 1ch. RS232C (3 pin) and 1ch. RS485 (2 pin)	AFPXCOM4
FP-X-COM5 communication cassette, 1ch. Ethernet (10Base-T, 100Base-TX) and 1ch. RS232C (3 pin)	AFPXCOM5
FP-X-COM6 communication cassette, 2x RS485, 115.2 kbit/s	AFPXCOM6
Control Configurator WD, tool software for setting the Ethernet port of the COM5 communication cassette	Free to download from our homepage

## FP-X accessories

Description	Part number
FP-X backup battery for backing up the operation memory and real-time clock	AFPXBATT
FP-X expansion cable	AFPXEC08 (8 cm), AFPXEC30 (30cm), AFPXEC80 (80cm)
FP-X terminal block for C30, C60 and E30, 21 pins, cover with no marking, set of 5 pcs.	AFPXTAN1

## FP-X0 CPUs

Description	Part number
FP-X0L14R, 8 IN (24V DC), 2 OUT (0.5 A/5 to 24V DC transistor), 4 OUT (2 A relay), 100 to 240V AC	AFPX0L14R
FP-X0L30R, 16 IN (24V DC), 4 OUT (0.5 A/5 to 24V DC transistor), 10 OUT (2 A relay), 100 to 240V AC	AFPX0L30R
FP-X0L40MR, 24 IN (24V DC), 4 OUT (0.5 A/5 to 24V DC transistor), 12 OUT (2 A relay), analog inputs (10 bits 2 channel), RS485, RTC, 100 to 240V AC	AFPX0L40MR
FP-X0L40R, 24 IN (24V DC), 4 OUT (0.5 A/5 to 24V DC transistor), 12 OUT (2 A relay), analog inputs (10 bits 2 channel), RTC, 100 to 240V AC	AFPX0L40R
FP-X0L60MR, 32 IN (24V DC), 4 OUT (0.5 A/5 to 24V DC transistor), 24 OUT (2 A relay), analog inputs (10 bits 2 channel), RS485, RTC, 100 to 240V AC	AFPX0L60MR
FP-X0L60R, 32 IN (24V DC), 4 OUT (0.5 A/5 to 24V DC transistor), 24 OUT (2 A relay), analog inputs (10 bits 2 channel), RTC, 100 to 240V AC	AFPX0L60R

## FP0R/FPΣ (Sigma)/FP-X network communication

Description	Part number
FP Web-Server 2, Ethernet with 10/100MBit/s and Modem interface	FPWEB2
FP Web Expansion Unit for FPWEB2	FPWEBEXP
IEC license for FPWEB2	IEC60870LIS
FPWEB Configurator Tool ver. 2	FPWEBTOOL2D
FP Web Designer, economy edition – HTML visualization for FPWEB2, limited for 250 process points, 15 views, 1 offline trend + 1 alarm	AFPS36510-E
FP Web Designer, basic edition – HTML visualization for FPWEB2, limited for 500 process points, 30 views, 3 offline trends + 1 alarm	AFPS36510-B
FP Web Designer, extended edition – HTML visualization for FPWEB2, no limitation	AFPS36510-X
Connection cable for FPWEB2 ↔ FP series PLC TOOL port, 2m	AIGT8192
FPΣ (Sigma) PROFIBUS DP master unit	FPG-DPV1-M
FPΣ (Sigma) DeviceNet master unit	FPG-DEV-M
FPΣ (Sigma) CANopen master unit	FPG-CAN-M
Control Configurator FM for Fieldbus Master Units	AFPS35510
FPΣ (Sigma) PROFIBUS DP slave unit	FPG-DPV1-S
FPΣ (Sigma) DeviceNet slave unit	FPG-DEV-S
FPΣ (Sigma) CANopen slave unit	FPG-CAN-S
FPΣ (Sigma) PROFINET I/O slave unit	FPG-PRT-S
FPΣ (Sigma) BACnet-IP slave unit. 10/100 Mbit/s	FPG-BACIP-S
FPΣ (Sigma) BACnet-MSTP slave unit. 9600 to 76.800 Mbit/s	FPG-BACMSTP-S
FP0/FP0R PROFINET DP slave unit, or works as remote IO unit without controller	FP0DPS2D
MEWNET-F slave unit	FP0IOL
FPΣ (Sigma) S-Link master unit as expansion	FPGSL
FPΣ (Sigma) CC-Link slave unit as expansion	FPGCCL
C-NET adapter (RS232C/RS422), 100 to 240V AC	AFP8536CEJ
C-NET adapter (RS485) S2-Type, 30cm cable for FP0/FPΣ (Sigma)/FP2 TOOL port	AFP15402J
Programming cable for FP and GT series (9-pin Sub-D to 5-pin miniDIN), L type, 3m	AFC8513D
FP Modem-56k (56kBaud, V.23/V.32bis/V.34/V.90, RS232/RS485)	FP-modem-56k
RS232C cable for FP Modem-56k ↔ FP series PLC COM port (3 pins), 0.5m	CABMODPLC111D
RS232C cable for FP Modem-56k ↔ FP series PLC COM port (9 pins), 0.5m	CABMODPLC211D
RS232C cable for FP Modem-56k ↔ FP series PLC TOOL port (5 pins), 2m	CABMODPLC311D
RS232C cable for FP Modem-56k ↔ FP series PLC TOOL port (5 pins), 0.5m	AFS8TP
KS1 signal converter, Ethernet ↔ RS232C/RS485, 24V DC	AKS1202

## 24V DC power supply units

Description	Part number
Power Supply Unit 24W (primary 100 to 240V AC, 2 x secondary 24V DC/1A, short circuit protected)	FP-PS24-024E
Power Supply Unit 60W (primary 100 to 240V AC, 2 x secondary 24V DC/2.5A, short circuit protected)	FP-PS24-060E
Power Supply Unit 120W (primary 100 to 240V AC, 2 x secondary 24V DC/5A, short circuit protected)	FP-PS24-120E

## FP7 CPUs

Description	Part number
120k steps, operation speed 11ns, no Ethernet support	AFP7CPS31
120k steps, operation speed 11ns, Ethernet communication available	AFP7CPS31E
196k steps, operation speed 11ns, Ethernet communication available	AFP7CPS41E

## FP7 communication cassettes

Description	Part number
RS232C, 1 channel (insulated)	AFP7CCS1
RS232C, 2 channels (insulated)	AFP7CCS2
RS422 or RS485, 1 channel (insulated)	AFP7CCM1
RS422 or RS485, 2 channels (insulated)	AFP7CCM2
RS232C, 1 channel (insulated) and RS485	AFP7CCS1M1
Ethernet 100Base-TX/10Base-T	AFP7CCET1

## FP7 application cassettes

Description	Part number
2-channel analog input voltage/current	AFP7FCAD2
2-channel analog input, 1-channel analog	AFP7FCA21
2-channel thermocouple input, K/J type	AFP7FCTC2

## FP7 digital input, output and mixed I/O units

Description	Part number
16 IN, 12–24V DC, configurable input time constant	AFP7X16DW
32 IN, 12–24V DC, configurable input time constant	AFP7X32D2
64 IN, 12–24V DC, configurable input time constant	AFP7X64D2
16 OUT, relay, 2A/point, 5A/common, 16 points/common	AFP7Y16R
16 OUT, transistor, PNP, load current 1.0A, 5A/common, 16 points/common	AFP7Y16P
16 OUT, NPN, load current: 1.0 A, 5 A/common, 16 points/common	AFP7Y16T
32 OUT, transistor, PNP, load current 0.3A, 3.2A/common, 32 points/common	AFP7Y32P
32 OUT, NPN, load current 0.3A, 3.2A/common, 32 points/common	AFP7Y32T
64 OUT, transistor, PNP, load current 0.3A/0.1A, 3.2A/common, 32 points/common	AFP7Y64P
64 OUT, load current: 0.3 A, 0.1 A, mixed 3.2 A /common, 32 points/common	AFP7Y64T
32 IN, 32 OUT, transistor, PNP, input: 24V DC, 32 points/common Output: load current 0.3A/0.1 A, 3.2A/common, 32 points/common	AFP7XY64D2P
32 IN, 32 OUT, NPN, input: 24V DC, 32 points/common Output: load current: 0.3 A, 0.1 A, mixed 3.2 A/common, 32 points/common	AFP7XY64D2T

## FP7 analog input and output units

Description	Part number
Input unit, 4 channels, voltage/current, conversion rate: 25µs/channel, resolution max. 16 bits, accuracy: max. ±0.05% F.S. (at 25°C)	AFP7AD4H
Output unit, 4 channels, voltage/current, conversion rate: 25µs/channel, resolution max. 16 bits, accuracy: max. ±0.05% F.S. (at 25°C)	AFP7DA4H

## FP7 high-speed counter units

Description	Part number
2 channels, 16MHz (for two-phase factor 4 input mode), 4MHz (for incremental/decremental input mode)	AFP7HSC2T
4 channels, 16MHz (for two-phase factor 4 input mode), 4MHz (for incremental/decremental input mode)	AFP7HSC4T

## FP7 positioning units

Description	Part number
Line driver, 2 axes, 1–4Mpps, electronic gear and cam function, linear interpolation, circular interpolation	AFP7PP02L
Line driver, 4 axes, 1–4Mpps, electronic gear and cam function, linear interpolation, circular interpolation	AFP7PP04L
Transistor, 2 axes, 1–500kpps, electronic gear and cam function, linear interpolation, circular interpolation	AFP7PP02T
Transistor, 4 axes, 1–500kpps, electronic gear and cam function, linear interpolation, circular interpolation	AFP7PP04T

## FP7 pulse output units

Description	Part number
Line Driver, 2 axis, 1pps to 500kpps	AFP7PG02L
Line Driver, 4 axis, 1pps to 500kpps	AFP7PG04L
Transistor, 2 axis, 1pps to 4Mpps	AFP7PG02T
Transistor, 4 axis, 1pps to 4Mpps	AFP7PG04T

## FP7 serial communication unit

Description	Part number
2 cassettes per unit, max. 8 units can be installed per CPU	AFP7NSC

## FP7 power supply units

Description	Part number
Power supply unit, input 100–240V AC, output 24VDC 1.0A	AFP7PSA1
Power supply unit, input 100–240V AC, output 24VDC 1.8A	AFP7PSA2

## Control FPWIN Pro

Description	Part number
Control FPWIN Pro programming software, version 7, version for all FP series PLCs	FPWINPRO7
Control FPWIN PRO upgrade to version 7	FPWINPRO7-UP
Programming cable (FP0R/FP0/FP-e/FPG/FPX/FP2 TOOL port to PC) miniDIN5 to 9-pin Sub-D; 2m	AFC8513D
Cable with USB 1.1 to RS232 with 9-pin Sub-D converter; 2m	CABUSBSER9D
Programming cable: USB A to USB B, 2m	AFPXCABUSB2D
Programming cable, USB A to mini USB B (5pin), 2m, USB2.0 compatible	CABMINIUSB5D

## FP Memory Loader

Description	Part number
FP Memory Loader, data non-hold type	AFP8670
FP Memory Loader, data hold type	AFP8671

## Other software products

Description	Part number
FPWEB Configurator Tool ver. 2	FPWEBTOOL2
FP Web Designer, economy edition – HTML visualization for FPWEB2, limited for 250 process points, 15 views, 1 offline trend + 1 alarm	AFPS36510-E
FP Web Designer, basic edition – HTML visualization for FPWEB2, limited for 500 process points, 30 views, 3 offline trends + 1 alarm	AFPS36510-B
FP Web Designer, extended edition – HTML visualization for FPWEB2, no limitation	AFPS36510-X
Control Configurator FM for Fieldbus Master Units	AFPS35510
Control Configurator MS, Setup software for alarm message system based on FP0R	AFPS34610D
Configurator ET, for FP2-ET2	AFPS32510D
Control Configurator WD for Ethernet configuration DLU, GT32T1, AFPX-COM5 and KS1, free download from <a href="http://www.panasonic-electric-works.com">www.panasonic-electric-works.com</a>	Control Configurator WD
FP OPC Server	AFPS03510D
FP Data Analyzer, monitoring software for all FP series PLCs	AFPS04510
PCWAY software + USB port dongle: Data monitoring in Excel format	AFW10031J
USB port dongle for PC Way software	AFW1033J
FPGT loader: up/download all programs and data from FP series PLCs and GT panels	AFPS77510
Control FP Connect software: One ActiveX control for MFC, Visual Basic and C#, Office applications and COM applications to communicate with FP series PLCs	AFPS37510

## Connection technology: UM connector terminal

Description	Part number
UM connector – terminal without LED (8-pin connection to PLC, via flat cable to FP0/FP0R/FPΣ)	UM45-FLK14PLC
UM connector – terminal with LED (8-pin connection to PLC, via flat cable to FP0/FP0R/FPΣ)	UM45-FLK14LAPLC
Flat cable with connector, UM (14 pins) ↔ FP0R/FPΣ input connector (10 pins)	CABUM45005X (0.5m), CABUM4501X (1m), CABUM4503X (3m)
Flat cable with connector, UM (14 pins) ↔ FP0R/FPΣ output connector (10 pins)	CABUM45005Y (0.5m), CABUM4501Y (1m), CABUM4503Y (3m)

## Connection technology: PLC relay terminal

Description	Part number
PLC relay terminal with 8 relays (changeover contact with screw terminal) for connecting to FP-series PLCs	PLC-BSC
Flat cable with connector, PLC-BSC (14 pins) ↔ FP0/FP0R (10 pins), 3m	CABPLCBSC03
Relay terminal with 8 relays (changeover contact with screw terminal) for connecting to FP-series PLCs	AFPRT8
Flat cable with connector, AFPCT10PINS/AFPRT8 (10 pins) ↔ FP0/FPΣ (10 pins), 1m	CABAFPCT10PINS
FP0-RT80-6A, relay terminal with 8 relays AC250V/2A, MC connector	FP0-RT8Y-6A

## Connection technology: MMFP power relay terminal

Description	Part number
Flat cable with connector, MMFP30R ↔ PLC, 40 pins, 1m	FC40FF/1

Please refer to the connection technology catalog for details.

## Connection technology: MF connector terminal

Description	Part number
MF20 connector terminal (20 screw terminal connection using 20-pin header)	MF20MD
MF40 connector terminal (40 screw terminal connection using 40-pin header)	MF40MD
Flat cable with connector, MF40MD <—> PLC, 40 pins, 1m	FC40FF/1
Flat cable with connector, AFPRT8/AFPCT10PINS <—> PLC, 40 pin via 4x 10 pin, 1m	AFP0541
Connector terminal with LED (8 connection via flat cable to FP0/FPΣ)	AFPCT10PINS
Flat cable with connector, AFPCT10PINS/AFPRT8 (10 pins) <—> FP0/FPΣ I/O (10 pins), 1m	CABAFPCT10PINS

## Connection technology: RT3 relay terminal

Description	Part number
RT3S relay terminal with 4 exchangeable relay, 24V DC coil, screw terminal, max. switching power: 30V DC, 250V AC, 2A	RT3S24J
RT3S PhotoMOS relay terminal with 4 exchangeable relays, 24V DC coil, screw terminal, max. switching power: 30V DC, 2A	RT3SP124J
RT3S PhotoMOS relay terminal with 4 exchangeable relays, 24V DC coil, screw terminal, max. switching power: 30V DC, 250V AC, 0.3A	RT3SP224J

## Web Datalogger unit

Description	Part number
Web Datalogger unit (DLU), log data of up to 99 devices	AFL1200
IP setting tool, Control Configurator WD	free to download
RS485 cassette pack including DLU, RS485 communication cassette, battery	AFL1200T20
"Eco Starter Pack" including DLU unit, RS485 communication cassette, power meter, setting and monitoring software, cables, manuals	AFL1200T10

## Further Panasonic products

Panasonic Electric Works offers a wide product range from one source, from individual components to complete systems. Technology support for advice, design-in, installation and commissioning by our qualified application engineers round off the Panasonic service profile.



### Human Machine Interfaces

Our compact size, bright and easy-to-read Human Machine Interfaces can be used to visualize inspection results. Touch panels can even replace the standard keypad if you so desire.



### Servo drives

Panasonic servo drives enable high performance motion control to be applied to almost all types of machines, including chip mounting machines and general industrial machines.

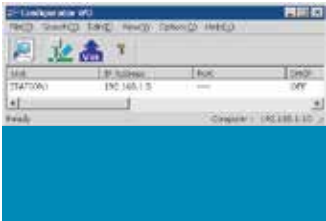

### UV curing systems

Aicure UJ30 is a LED curing system that quickly hardens UV-sensitive resins such as adhesives, ink and coatings. Its cutting edge LED technology is especially suited for precise, high-intensity curing.



### ACD components

Components such as Eco-POWER METERS, timers/counters, temperature controllers, limit switches and fans round off our wide Factory Automation product range.

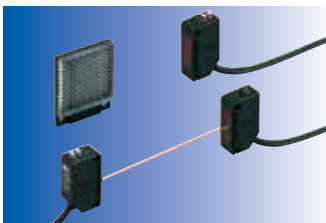

### Sensors

As a pioneering manufacturer of sensors, Panasonic provides high performance sensors for a wide range of applications, facilitating factory automation in various types of production lines, such as those used for the manufacturing of semiconductors.



### Laser Markers

Panasonic Laser Markers are ideal for non-contact, permanent labelling of most materials, e.g. plastics, glass, paper, wood and leather. Several CO<sub>2</sub> laser marking systems and a unique FAYb Laser Marker can be easily integrated into existing production systems for a great variety of labelling tasks.

North America

Europe

Asia Pacific

China

Japan

## Panasonic Electric Works

Please contact our Global Sales Companies in:

### Europe

▶ <b>Headquarters</b>	<b>Panasonic Electric Works Europe AG</b>	Rudolf-Diesel-Ring 2, 83607 Holzkirchen, Tel. +49 (0) 8024 648-0, Fax +49 (0) 8024 648-111, <a href="http://www.panasonic-electric-works.com">www.panasonic-electric-works.com</a>
▶ <b>Austria</b>	<b>Panasonic Electric Works Austria GmbH</b>	Josef Madersperger Str. 2, 2362 Biedermansdorf, Tel. +43 (0) 2236-26846, Fax +43 (0) 2236-46133 <a href="http://www.panasonic-electric-works.at">www.panasonic-electric-works.at</a>
	<b>Panasonic Industrial Devices Materials Europe GmbH</b>	Ennschafenstraße 30, 4470 Enns, Tel. +43 (0) 7223 883, Fax +43 (0) 7223 88333, <a href="http://www.panasonic-electronic-materials.com">www.panasonic-electronic-materials.com</a>
▶ <b>Benelux</b>	<b>Panasonic Electric Works Sales Western Europe B.V.</b>	De Rijn 4, (Postbus 211), 5684 PJ Best, (5680 AE Best), Netherlands, Tel. +31 (0) 499 372727, Fax +31 (0) 499 372185, <a href="http://www.panasonic-electric-works.nl">www.panasonic-electric-works.nl</a>
▶ <b>Czech Republic</b>	<b>Panasonic Electric Works Europe AG</b>	Administrative centre PLATINIUM, Veveří 3163/111, 616 00 Brno, Tel. +420 541 217 001, Fax +420 541 217 101, <a href="http://www.panasonic-electric-works.cz">www.panasonic-electric-works.cz</a>
▶ <b>France</b>	<b>Panasonic Electric Works Sales Western Europe B.V.</b>	Succursale française, 10, rue des petits ruisseaux, 91370 Verrières Le Buisson, Tél. +33 (0) 1 6013 5757, Fax +33 (0) 1 6013 5758, <a href="http://www.panasonic-electric-works.fr">www.panasonic-electric-works.fr</a>
▶ <b>Germany</b>	<b>Panasonic Electric Works Europe AG</b>	Rudolf-Diesel-Ring 2, 83607 Holzkirchen, Tel. +49 (0) 8024 648-0, Fax +49 (0) 8024 648-111, <a href="http://www.panasonic-electric-works.de">www.panasonic-electric-works.de</a>
▶ <b>Hungary</b>	<b>Panasonic Electric Works Europe AG</b>	Magyarországi Közvetlen Kereskedelmi Képviselet, 1117 Budapest, Neumann János u. 1., Tel. +36 1 999 89 26 <a href="http://www.panasonic-electric-works.hu">www.panasonic-electric-works.hu</a>
▶ <b>Ireland</b>	<b>Panasonic Electric Works UK Ltd.</b>	Irish Branch Office, Dublin, Tel. +353 (0) 14600969, Fax +353 (0) 14601131, <a href="http://www.panasonic-electric-works.co.uk">www.panasonic-electric-works.co.uk</a>
▶ <b>Italy</b>	<b>Panasonic Electric Works Italia srl</b>	Via del Commercio 3-5 (Z.I. Ferlina), 37012 Bussolengo (VR), Tel. +39 0456752711, Fax +39 0456700444, <a href="http://www.panasonic-electric-works.it">www.panasonic-electric-works.it</a>
▶ <b>Nordic Countries</b>	<b>Panasonic Electric Works Europe AG</b> <b>Panasonic Eco Solutions Nordic AB</b>	Filial Nordic, Knarrarnäsgatan 15, 164 40 Kista, Sweden, Tel. +46 859476680, Fax +46 859476690, <a href="http://www.panasonic-electric-works.se">www.panasonic-electric-works.se</a>
▶ <b>Poland</b>	<b>Panasonic Electric Works Polska sp. z o.o.</b>	Jungmansgatan 12, 21119 Malmö, Tel. +46 40 697 7000, Fax +46 40 697 7099, <a href="http://www.panasonic-fire-security.com">www.panasonic-fire-security.com</a>
▶ <b>Spain</b>	<b>Panasonic Electric Works España S.A.</b>	ul. Wołoska 9A, 02-583 Warszawa, Tel. +48 22 338-11-33, Fax +48 22 338-12-00, <a href="http://www.panasonic-electric-works.pl">www.panasonic-electric-works.pl</a>
▶ <b>Switzerland</b>	<b>Panasonic Electric Works Schweiz AG</b>	Barajas Park, San Severo 20, 28042 Madrid, Tel. +34 913293875, Fax +34 913292976, <a href="http://www.panasonic-electric-works.es">www.panasonic-electric-works.es</a>
▶ <b>United Kingdom</b>	<b>Panasonic Electric Works UK Ltd.</b>	Grundstrasse 8, 6343 Rotkreuz, Tel. +41 (0) 41 7997050, Fax +41 (0) 41 7997055, <a href="http://www.panasonic-electric-works.ch">www.panasonic-electric-works.ch</a>
		Sunrise Parkway, Linford Wood, Milton Keynes, MK14 6LF, Tel. +44 (0) 1908 231555, Fax +44 (0) 1908 231599, <a href="http://www.panasonic-electric-works.co.uk">www.panasonic-electric-works.co.uk</a>

### North & South America

▶ <b>USA</b>	<b>Panasonic Industrial Devices Sales Company of America</b>	629 Central Avenue, New Providence, N.J. 07974, Tel. 1-908-464-3550, Fax 1-908-464-8513, <a href="http://www.pewa.panasonic.com">www.pewa.panasonic.com</a>
--------------	--	---

### Asia Pacific/China/Japan

▶ <b>China</b>	<b>Panasonic Electric Works Sales (China) Co. Ltd.</b>	Level 2, Tower W3, The Towers Oriental Plaza, No. 2, East Chang An Ave., Dong Cheng District, Beijing 100738, Tel. +86-10-5925-5988, Fax +86-10-5925-5973
▶ <b>Hong Kong</b>	<b>Panasonic Industrial Devices Automation Controls Sales (Hong Kong) Co., Ltd.</b>	RM1205-9, 12/F, Tower 2, The Gateway, 25 Canton Road, Tsimshatsui, Kowloon, Hong Kong, Tel. +852-2956-3118, Fax +852-2956-0398
▶ <b>Japan</b>	<b>Panasonic Corporation</b>	1048 Kadoma, Kadoma-shi, Osaka 571-8686, Japan, Tel. +81-6-6908-1050, Fax +81-6-6908-5781, <a href="http://www.panasonic.net">www.panasonic.net</a>
▶ <b>Singapore</b>	<b>Panasonic Industrial Devices Automation Controls Sales Asia Pacific</b>	300 Beach Road, #16-01 The Concourse, Singapore 199555, Tel. +65-6390-3811, Fax +65-6390-3810